

Recommended P.C.B. Layout

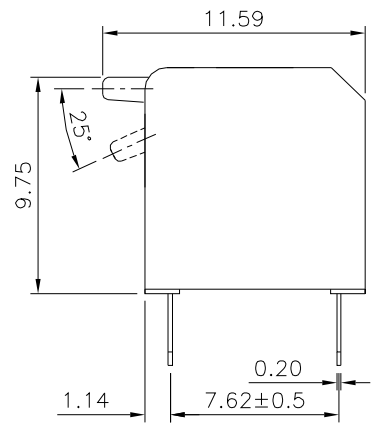
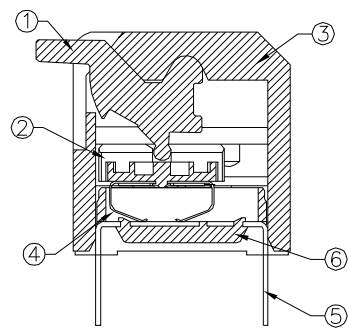
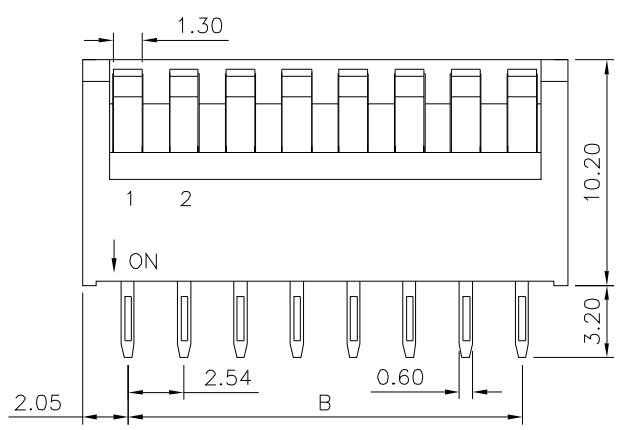
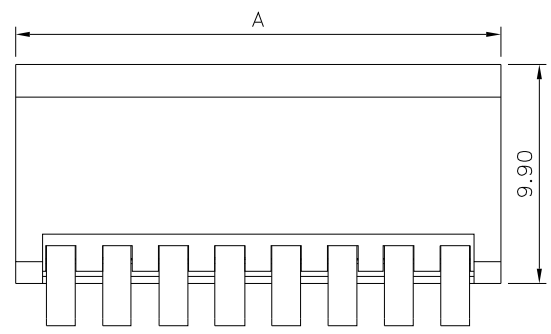

SPECIFICATION

Current Range:
 Non-Switching: 100mA 50V DC
 Switching: 25mA 24V DC
 Dielectric Withstanding Voltage: 500V AC For One Minute
 Contact Resistance: 50 Milliohms Max. (Initial)
 Insulation Resistance: 100 Megaohms Min.
 At 500V DC, 60s ± 5s
 Operation Temperature Range: -40°C ~ +85°C
 Storage Temperature Range: -40°C ~ +85°C
 RoHS Compliant

Pin	A	B
2	6.64	2.54
3	9.18	5.08
4	11.72	7.62
5	14.26	10.16
6	16.80	12.70
7	19.34	15.24
8	21.88	17.78
9	24.42	20.32
10	26.96	22.86
12	32.04	27.94

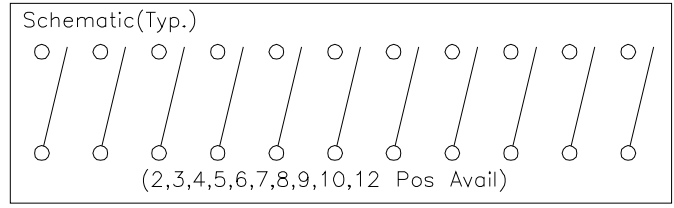

No.	Description	Q'ty	Material	Remark
⑥	Base	1	PA66,UL94V-0	Black
⑤	Terminal	1	Brass	Gold Plated Over Nickel
④	Contact	1	Copper Alloy	Gold Plated Over Nickel
③	Cover	1	PBT,UL94V-0	Red
②	Slider	1	PBT,UL94V-0	White
①	Lever	1	PBT,UL94V-0	White

4UCON 元化興業股份有限公司
 4UCON TECHNOLOGY INC.

DRAWING No.		APPROVED BY		UNLESS OTHERWISE SPECIFIED TOLERANCES ARE .X ± 0.20 .XX ± 0.20 ANG.
12086		MEI		
		CHECKED BY	HZF	
		DRAWING BY	CYP	
SCALE	NONE	REV.	B0	UNIT mm

△ B0	NEW RELEASE	HZF	02/18/2020
NO. REV.	REVISIONS	CHK	DATE