

Recommended P.C.B. Layout(Top Side)
(PCB Board Tolerance ± 0.05)

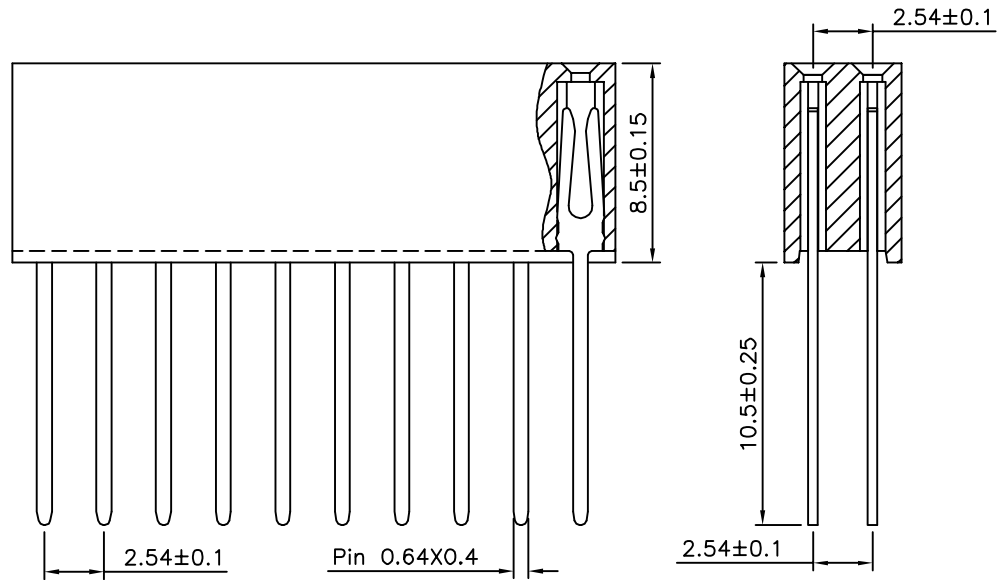
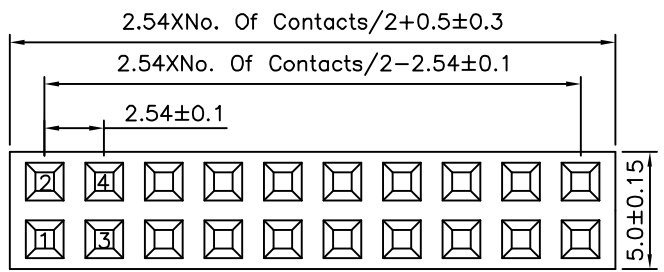

SPECIFICATION

Current Rating:3A
 Withstand Voltage:500V AC
 Contact Resistance:20 Milliohms Max.
 Insulation Resistance:1000 Megaohms Min.
 Operation Temperature:-40°C~+105°C
 Housing:PBT(UL94V-0),Black
 Contact:Brass,Gold Flash Over Nickel
 RoHS Compliant

4UCON 元化興業股份有限公司
 4UCON TECHNOLOGY INC.

DRAWING No.		APPROVED BY		UNLESS OTHERWISE SPECIFIED TOLERANCES ARE X. ± 0.25 X.* $\pm 2^\circ$.X ± 0.20 .X* $\pm 1.5^\circ$.XX ± 0.15 .XX* $\pm 1^\circ$.XXX ± 0.10 .XXX* $\pm 0.5^\circ$
20582		EMILY		
		CHECKED BY		
		HZF		
		DRAWING BY		
		SAN		
SCALE	NONE	REV.	A0	UNIT
				mm

NO.	REV.	REVISIONS	CHK	DATE
△ A0		NEW RELEASE	HZF	10/04/2013