

Recommended P.C.B. Layout(Top Side)  
(PCB Board Tolerance  $\pm 0.05$ )

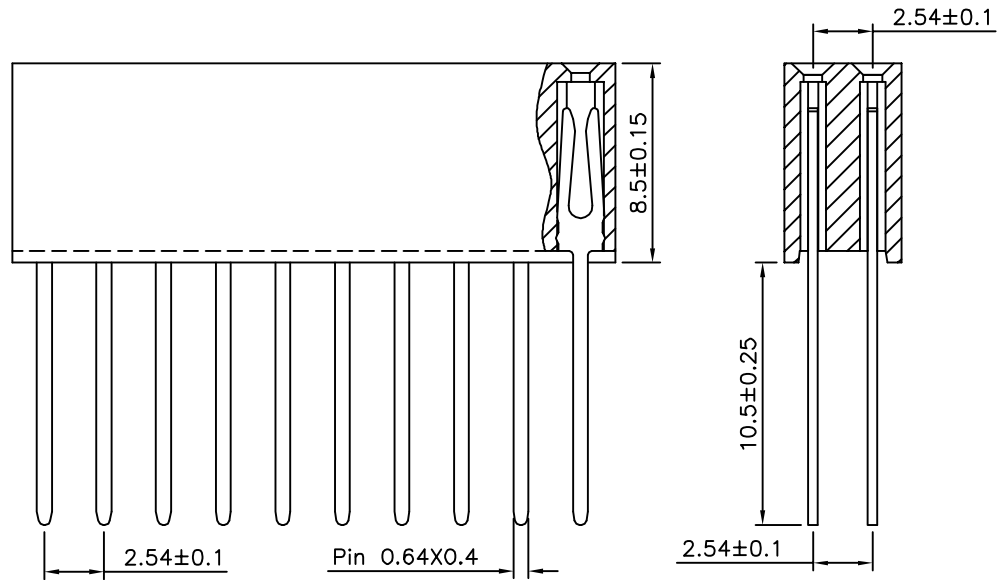
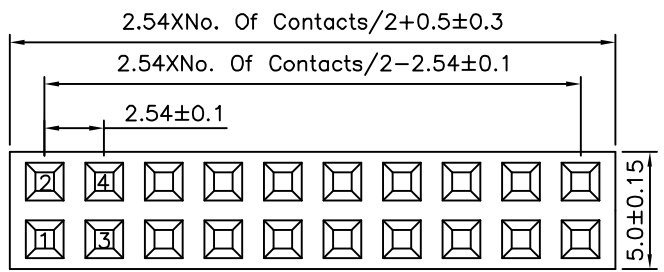

**SPECIFICATION**

Current Rating:3A  
 Withstand Voltage:500V AC  
 Contact Resistance:20 Milliohms Max.  
 Insulation Resistance:1000 Megaohms Min.  
 Operation Temperature:-40°C~+105°C  
 Housing:PBT(UL94V-0),Black  
 Contact:Brass,Gold Flash Over Nickel  
 RoHS Compliant

**4UCON** 元化興業股份有限公司  
 4UCON TECHNOLOGY INC.

DRAWING No.		APPROVED BY		UNLESS OTHERWISE SPECIFIED TOLERANCES ARE X. $\pm 0.25$ X.* $\pm 2^\circ$ .X $\pm 0.20$ .X* $\pm 1.5^\circ$ .XX $\pm 0.15$ .XX* $\pm 1^\circ$ .XXX $\pm 0.10$ .XXX* $\pm 0.5^\circ$
20171		EMILY		
		CHECKED BY		
		HZF		
		DRAWING BY		
		SAN		
SCALE	NONE	REV.	A0	UNIT
				mm

NO.	REV.	REVISIONS	CHK	DATE
△ A0		NEW RELEASE	HZF	10/04/2013