

SPECIFICATION

Current Rating:1 Amp
 Dielectric Withstanding Voltage:AC 1000V For 1 Minute
 Insulation Resistance:1000 Megohms Min. At DC 500V
 Contact Resistance:30 Milliohms Max. At DC 100mA
 ⚠ Operation Temperature:-55°C~+125°C
 Housing:LCP(UL94V-0)
 Contact:Brass
 Gold Plated 10u" On Contact Area
 Tin Plated On Solder Tails,Over Nickel
 RoHS Compliant

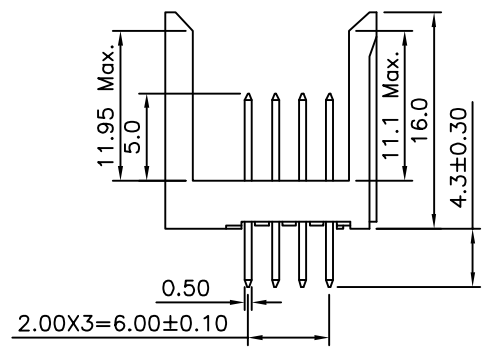
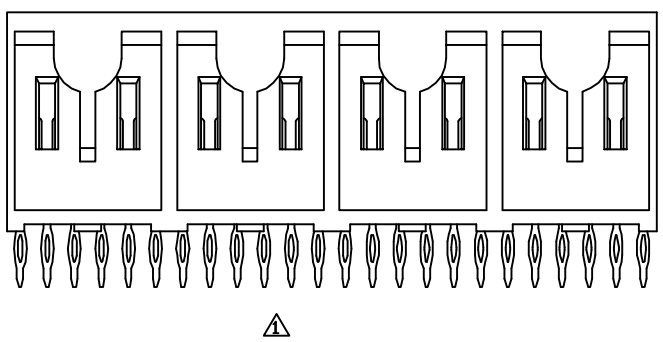
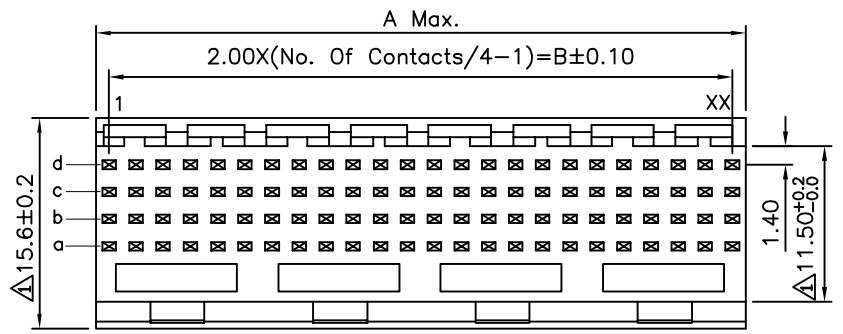
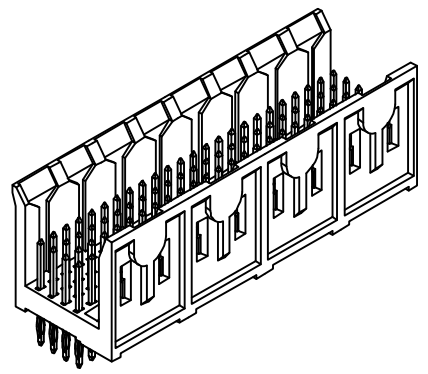
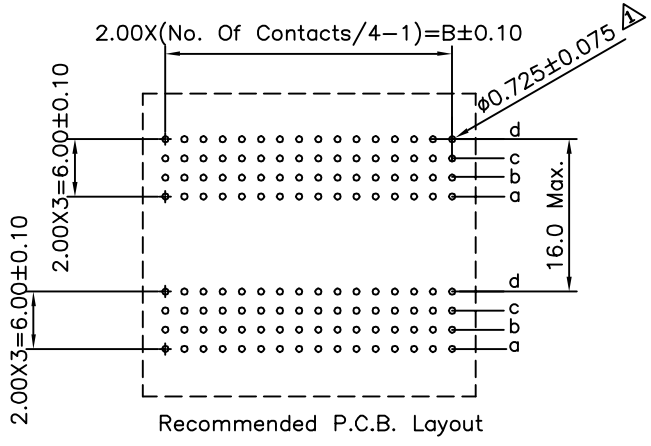

Pin	A	B
24	11.95	10
48	23.95	22
72	35.95	34
96	47.95	46
120	59.95	58
144	71.95	70
168	83.95	82
192	95.95	94

4UCON 元化興業股份有限公司
 4UCON TECHNOLOGY INC.

DRAWING No.		APPROVED BY		UNLESS OTHERWISE SPECIFIED TOLERANCES ARE
18200		EMILY		
		CHECKED BY		
		HZF		X. ±0.5
		DRAWING BY		.X ±0.25
		YBL		.XX ±0.15
SCALE	NONE	REV.	A1	UNIT
				mm

NO.	REV.	REVISIONS	CHK	DATE
⚠ A1		Modify Data	HZF	12/20/2013
⚠ A0		NEW RELEASE	HZF	01/02/2009