

Recommended P.C.B. Layout (Top Side)
(PCB Board Tolerance ±0.05)

△ SPECIFICATION
 Current Rating: 3.0 Amp
 Withstand Voltage: 500V AC/DC
 Contact Resistance: 20 Milliohms Max.
 Insulation Resistance: 1000 Megaohms Min.
 Operation Temperature: -40°C ~ +105°C
 Contact: Brass, Gold Plated Over Nickel
 Insulator: PBT+30%G.F.(UL94V-0), Black
 RoHS Compliant

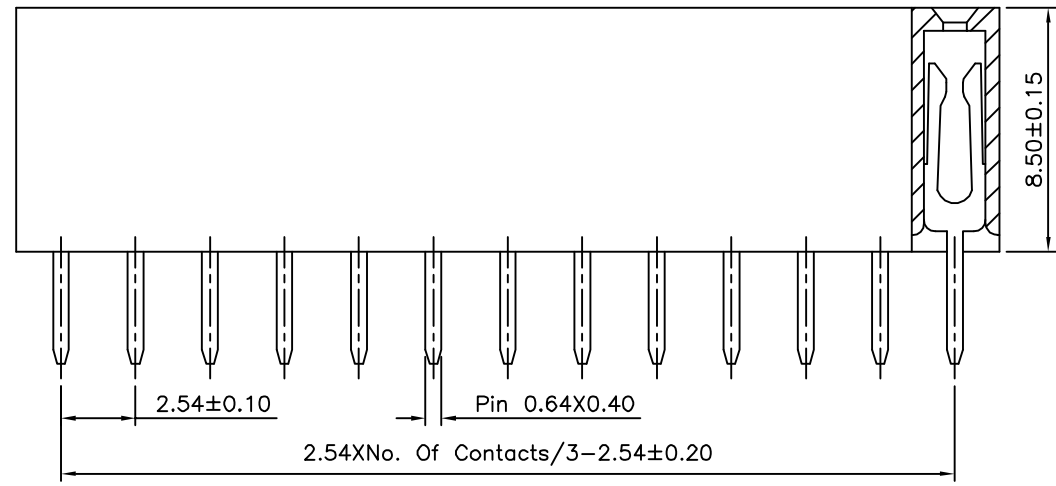

Section A-A

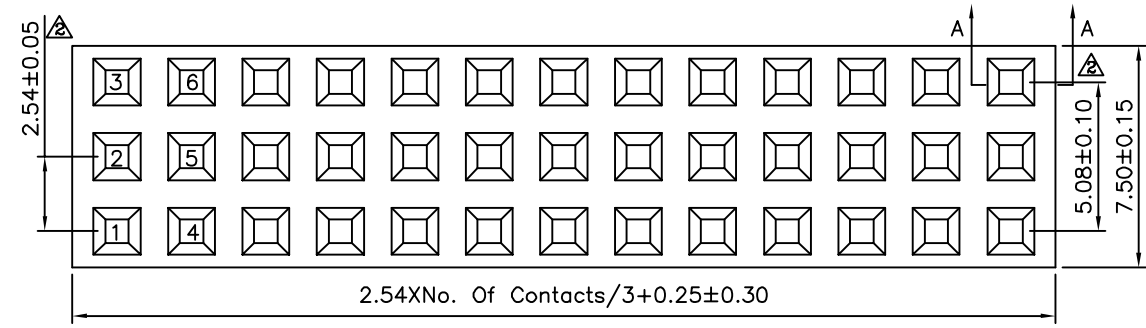
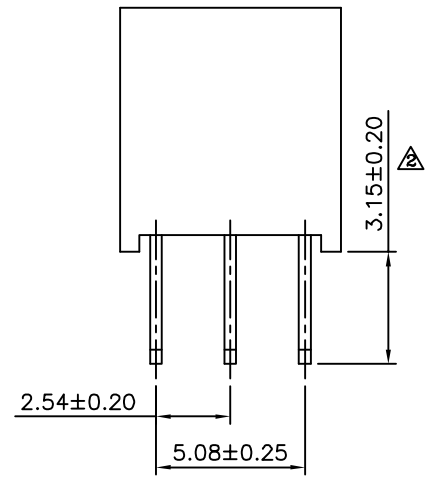

4UCON 元化興業股份有限公司
 4UCON TECHNOLOGY INC.

DRAWING No.		APPROVED BY		UNLESS OTHERWISE SPECIFIED TOLERANCES ARE △ .X ±0.40 .XX ±0.25 .XXX ±0.15 ANG. ±3°
16618		EMILY		
		CHECKED BY HZF		
		DRAWING BY SONG		
SCALE	NONE	REV.	A2	UNIT mm

NO.	REV.	REVISIONS	CHK	DATE
△ A2		Modify Data	HZF	10/31/2011
△ A1		Modify Data	BECKY	11/15/2005
△ A0		NEW RELEASE	BECKY	05/03/2005