

**SPECIFICATION**

Current Rating:1.0 Amp  
 Withstand Voltage:500V AC/DC  
 Contact Resistance:20 Milliohms Max.  
 Insulation Resistance:1000 Megaohms Min.  
 Operation Temperature:-40°C~+105°C  
 Contact:Phosphor Bronze,Gold Plated Over Nickel  
 Insulator:PA9T+30%G.F.(UL94V-0),Black  
 RoHS Compliant

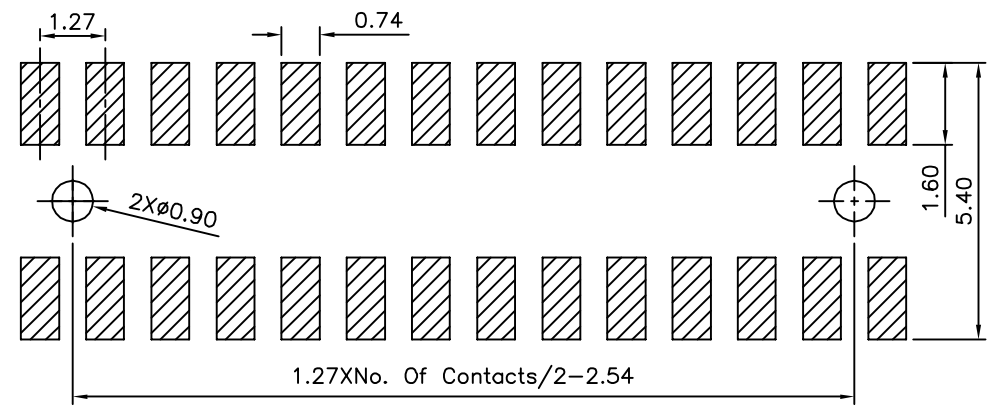

**Recommended P.C.B Layout(Top Side)**  
 (PCB Board Tolerance:±0.05)

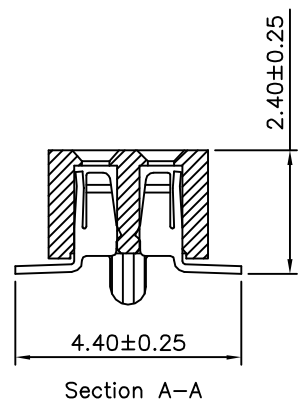
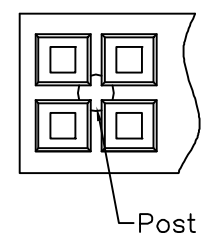
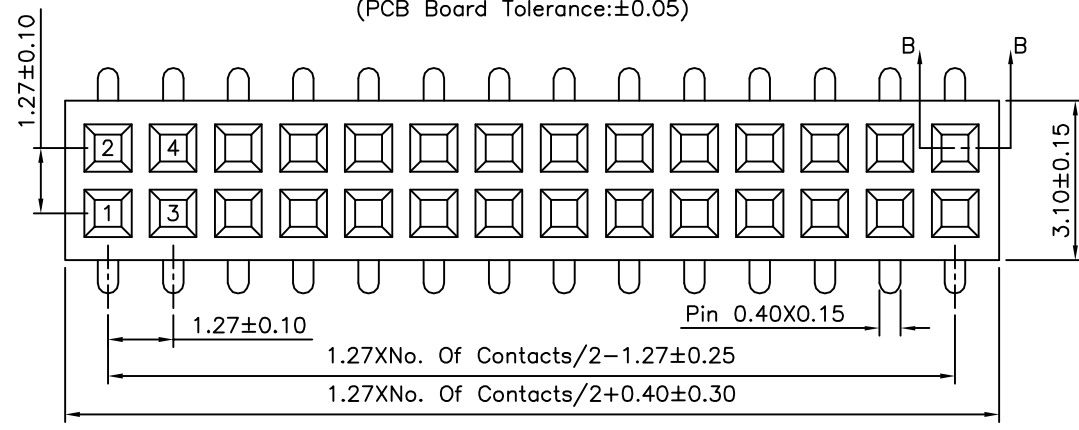

**4UCON** 元化興業股份有限公司  
 4UCON TECHNOLOGY INC.

DRAWING No.		APPROVED BY		UNLESS OTHERWISE SPECIFIED TOLERANCES ARE .X ±0.40 .XX ±0.25 .XXX ±0.15 ANG. ±3°
10751		EMILY		
		CHECKED BY		
		HZF		
		DRAWING BY		UNIT mm
		HAO		
SCALE	NONE	REV.	BO	NO. REV.

BO	NEW RELEASE	HZF	12/08/2014
NO. REV.	REVISIONS	CHK	DATE