

SPECIFICATIONS
Insulator: ABS UL 94HB

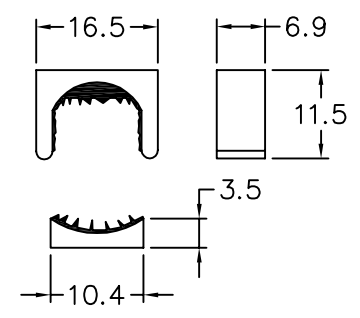
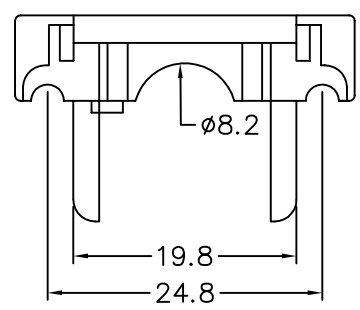
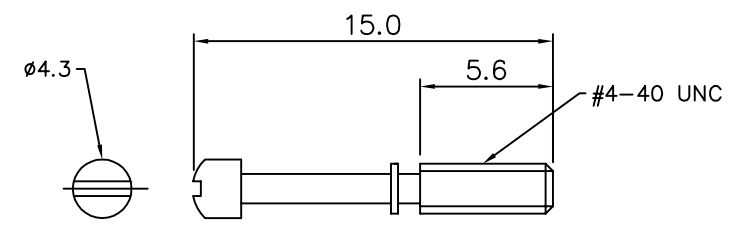
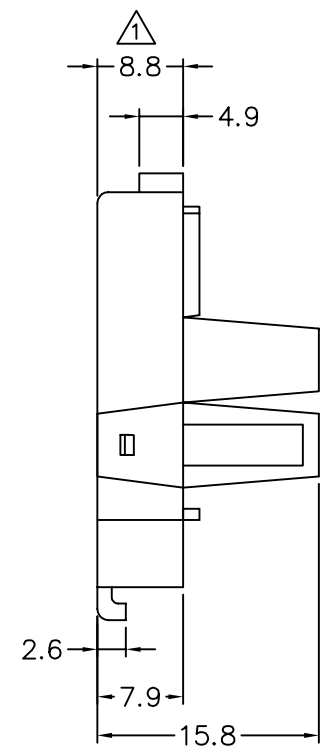
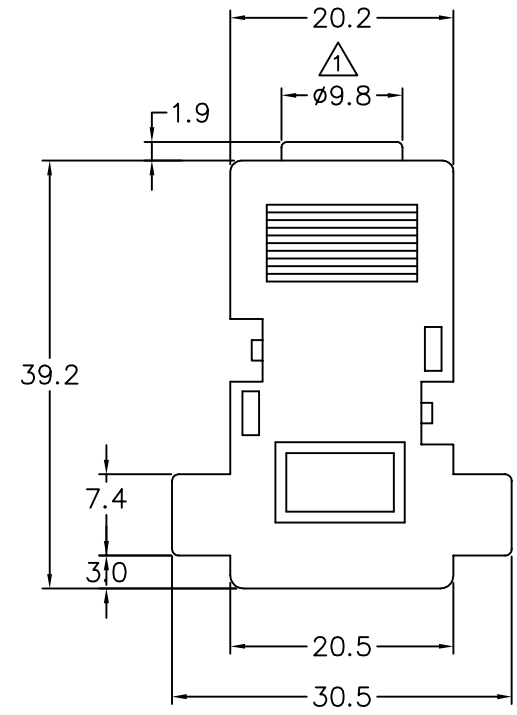

4UCON 元化興業股份有限公司
4UCON TECHNOLOGY INC.

DRAWING No.		APPROVED BY		UNLESS OTHERWISE SPECIFIED TOLERANCES ARE .X ±0.38 .XX ±0.25 AWG.
03099		MEI		
		RAN		
		DRAWING BY		
		HZF		
SCALE	NONE	REV.	A	UNIT mm

AREA	CHANGE DIM. REVISIONS	MEI	11/15/2002
		CHK	DATE