

SPECIFICATIONS:
 Contact Current Rating:1 Ampere
 Dielectric Withstanding Voltage: AC 500V R.M.S.
 Insulation Resistance : 500Megohms Min. At DC 500V
 Contact Resistance:30Milliohms. Max.
 Operating Temperature:-55°C ~+105°C
 Contact:Brass , Gold Flashed
 Insulator:P.B.T.UL94V-0 Rated
 Shell:Cold Rolled Steel,Nickel ,Tin,Zinc Plated

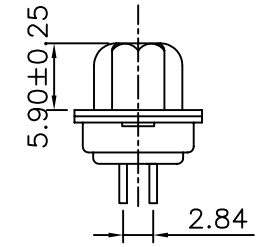
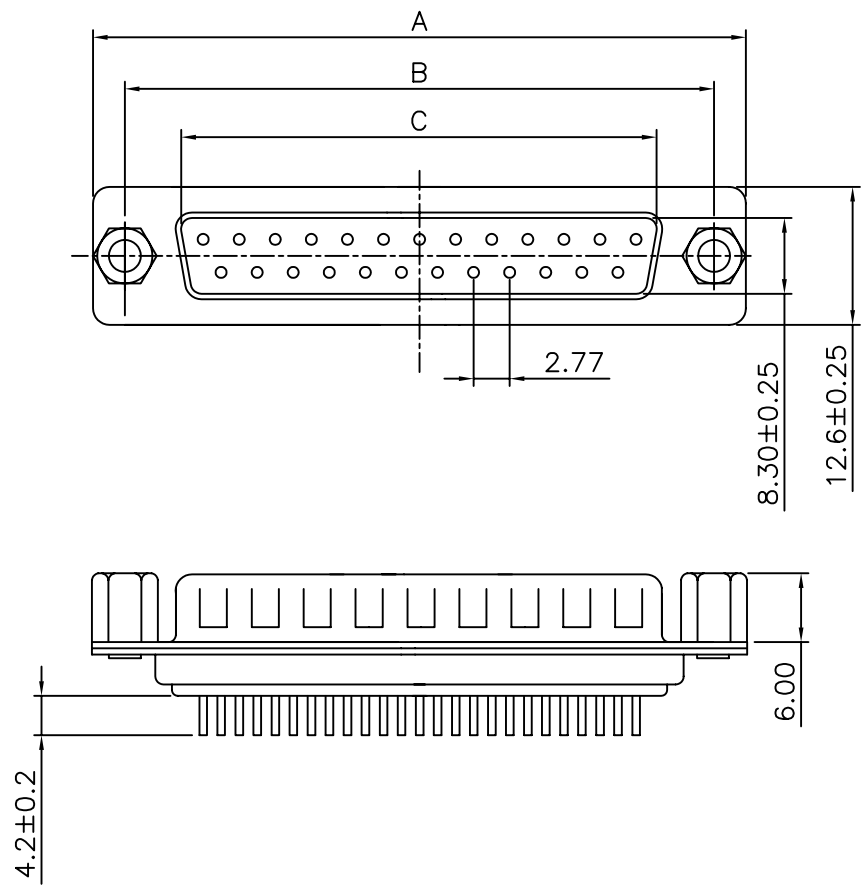

Circuits	A±0.25	B±0.25	C±0.25
09	30.80	25.00	19.92
15	39.20	33.32	25.25
19	44.80	38.86	30.60
23	50.30	44.30	36.10
25	53.05	47.04	38.96
37	69.40	63.50	55.42

4UCON 元化興業股份有限公司
 4UCON TECHNOLOGY INC.

DRAWING No.		APPROVED BY		UNLESS OTHERWISE SPECIFIED TOLERANCES ARE .X ±0.38 .XX ±0.25 AWG.
02878		MEI		
		RAN		
		DRAWING BY		
		HZF		
SCALE	NONE	REV.	A	UNIT mm

NO.	REV.	REVISIONS	CHK	DATE
△	A	NEW RELEASE	RAN	