

Recommended P.C.B. Layout

SPECIFICATION

Current Rating: 10 Amp/Way Max.
 Voltage Rating: 150V AC
 Withstanding Voltage: 2000V AC/Minute
 Test Time=60 Sec/1 PCS
 Contact Resistance: 20 Milliohms Max.
 Wire Range: 16~30 AWG
 Torque: 2kgf.cm/M2
 Operating Temperature: -40°C~+105°C
 Soldering Reliability: Test Temperature=250°C±10°C
 5 Seconds Max.
 Terminal: Copper Alloy, Tin Plated
 Screw: Steel, Galvanized And With Cr3+ Plated
 Wire Guard: Stainless Steel
 Insulator Body(Housing): Polyamide(UL94V-0), Blue
 RoHS Compliant

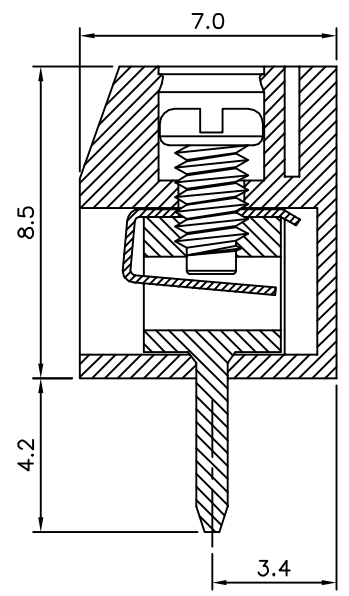
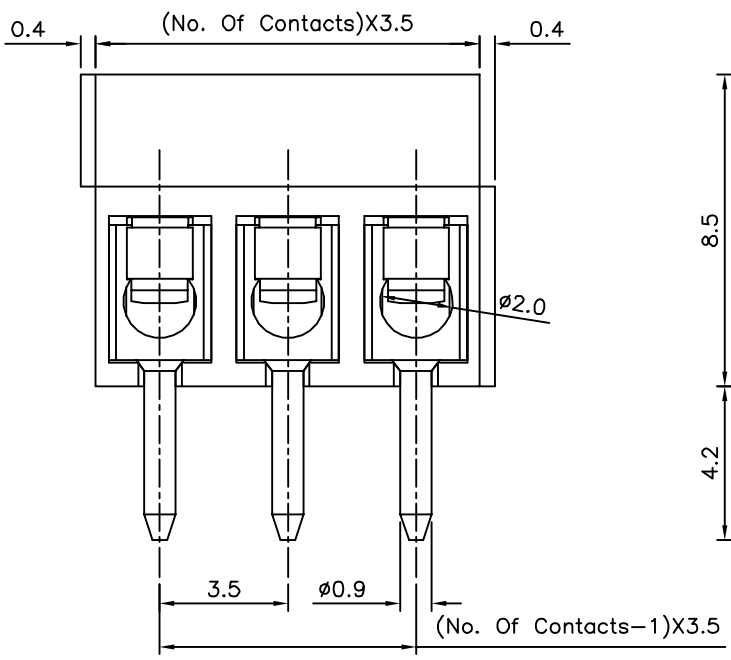

4UCON 元化興業股份有限公司
 4UCON TECHNOLOGY INC.

DRAWING No.		APPROVED BY		UNLESS OTHERWISE SPECIFIED TOLERANCES ARE X. ±0.50 .X ±0.30 .XX ±0.20 ANG. ±1°
19964		EMILY		
		CHECKED BY HZF		
		DRAWING BY WSS		
SCALE	NONE	REV.	BO	UNIT mm

NO.	REV.	REVISIONS	CHK	DATE
△ BO		NEW RELEASE	HZF	10/26/2014