

Recommended P.C.B. Layout

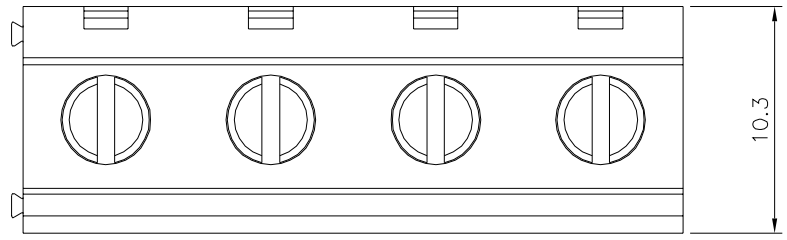

**△ SPECIFICATION**  
 Voltage Rating:300V AC  
 Current Rating:16 Amps/Way Max.  
 Contact Resistance:20 Milliohms Max.  
 Withstanding Voltage:2500V AC(1 Minute)  
 Test Time=60 Sec./PCS  
 Wire Range:12~30 AWG  
 △ Torque:4.5 Kgf.cm/M3.0  
 Operation Temperature:-40°C~+105°C  
 Soldering Reliability:250°C±10°C/5 Seconds Max.  
 Contact(Metal Housing):Copper Alloy,Nickel Plated  
 Terminal Screw:Steel,Galvanized And With Cr3+ Plated  
 Solder Pin:Copper Alloy,Tin Plated  
 Insulator Body(Housing):Polyamide(UL94V-0),Green  
 RoHS Compliant

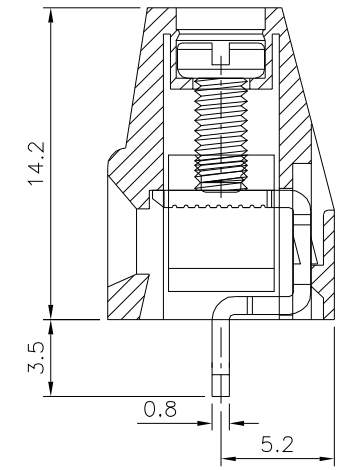
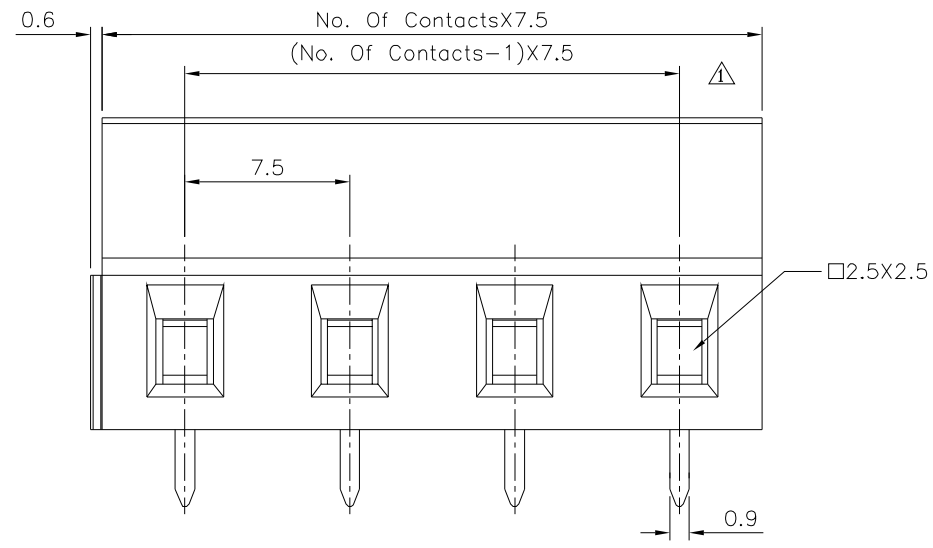

**4UCON** 元化興業股份有限公司  
 4UCON TECHNOLOGY INC.

DRAWING No.		APPROVED BY		UNLESS OTHERWISE SPECIFIED TOLERANCES ARE X. ±0.50 .X ±0.30 .XX ±0.20 ANG. ±1°
13707		MEI		
		CHECKED BY		
		HZF		
		DRAWING BY		UNIT mm
		CYP		
SCALE	NONE	REV.	A2	

NO.	REV.	REVISIONS	CHK	DATE
△	A2	Modify Data	HZF	04/20/2017
△	A1	Modify Data	HZF	03/20/2014
△	A0	NEW RELEASE	HZF	09/11/2010