

△△△ SPECIFICATION

- General Characteristics:**
1.0mm FPC XXP SMT 180° Non-ZIF Dual
Contact Parallel Layout
- Material&Finish:**
Insulator:PA9T(UL94V-0),Black
Contact:Phosphor Bronze,Tin Plated Over Nickel
- Electrical Characteristics:**
Current Rating:0.5A Max.
Voltage Rating:50V AC
Dielectric Withstanding Voltage:500V AC For 1 Minute
Contact Resistance:30 Milliohms Max.(Initial)
50 Milliohms Max.(Final)
Insulation Resistance:500 Megohms Min.(Initial)
At 500 DC
- Environmental Characteristics:**
Temperature Range:-20°C~+85°C
- RoHS Compliant**

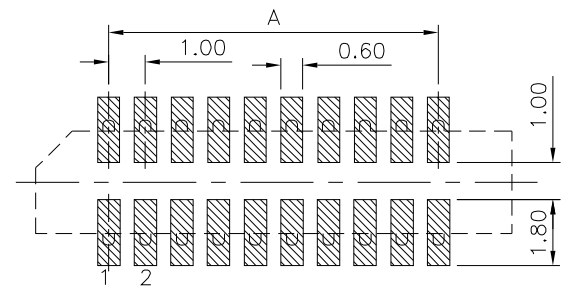

△ Recommended P.C.B. Layout
PCB Tolerance±0.05

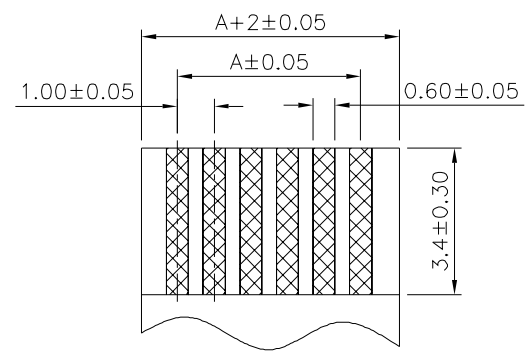

△ FPC/FFC T=0.30±0.05

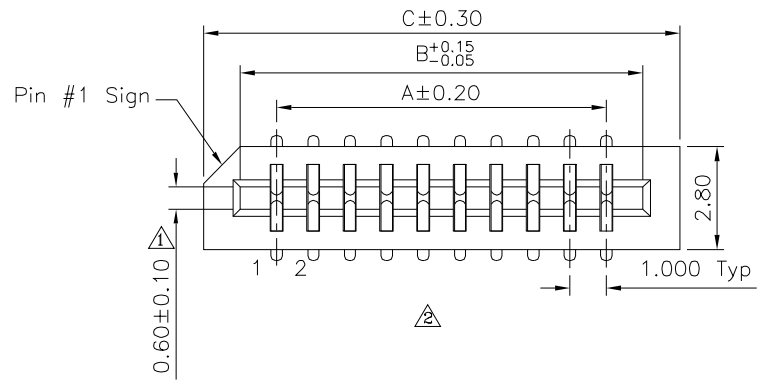

△

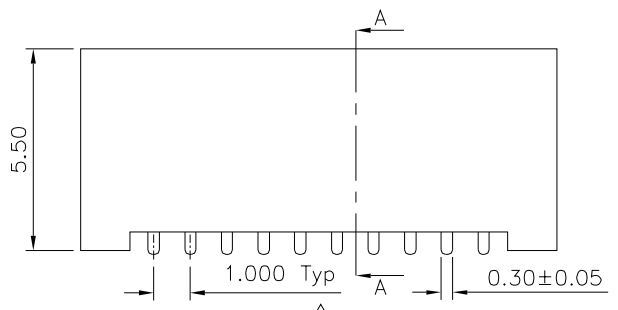

△

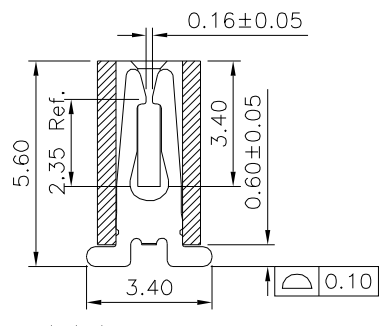

△△△ Section A-A

△

Pin	A	B	C	Pin	A	B	C
3	2.00	4.10	6.00	17	16.00	18.10	20.00
4	3.00	5.10	7.00	18	17.00	19.10	21.00
5	4.00	6.10	8.00	19	18.00	20.10	22.00
6	5.00	7.10	9.00	20	19.00	21.10	23.00
7	6.00	8.10	10.00	21	20.00	22.10	24.00
8	7.00	9.10	11.00	22	21.00	23.10	25.00
9	8.00	10.10	12.00	23	22.00	24.10	26.00
10	9.00	11.10	13.00	24	23.00	25.10	27.00
11	10.00	12.10	14.00	25	24.00	26.10	28.00
12	11.00	13.10	15.00	26	25.00	27.10	29.00
13	12.00	14.10	16.00	27	26.00	28.10	30.00
14	13.00	15.10	17.00	28	27.00	29.10	31.00
15	14.00	16.10	18.00	29	28.00	30.10	32.00
16	15.00	17.10	19.00	30	29.00	31.10	33.00

4UCON 元化興業股份有限公司
4UCON TECHNOLOGY INC.

DRAWING No.		APPROVED BY		UNLESS OTHERWISE SPECIFIED TOLERANCES ARE △ X. ±0.40 .X ±0.30 .XX ±0.20 .XXX ±0.10
12937		MEI		
		CHECKED BY	HZF	
SCALE	NONE	DRAWING BY	CYP	
		REV.	A3	UNIT mm

NO.	REV.	REVISIONS	CHK	DATE
△A3		Modify Data	HZF	09/15/2017
△A2		Modify Data	HZF	04/30/2013
△A1		Modify Data	HZF	04/30/2009
△A0		NEW RELEASE	BECKY	06/07/2005