

△△ SPECIFICATION
 Current Rating: 1 Amp
 Dielectric Withstanding Voltage:
 AC 1000V For 1 Minute
 Insulation Resistance: 1000 Megaohms Min.
 At DC 500V
 Contact Resistance: 30 Milliohms Max.
 At DC 100mA
 Operation Temperature: -55°C ~ +125°C
 Contacts: Phosphor Bronze
 Gold Plated 10u" On Contact Area
 Tin Plated On Solder Tails, Over Nickel
 Housing: LCP (UL94V-0)
 RoHS Compliant

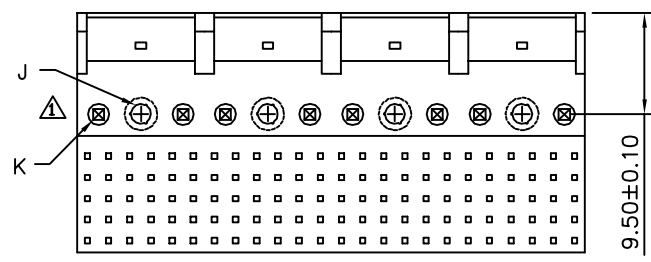
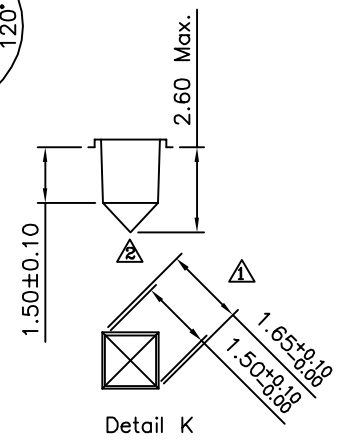
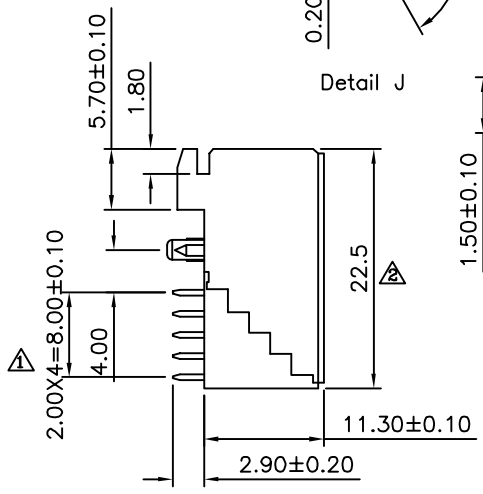
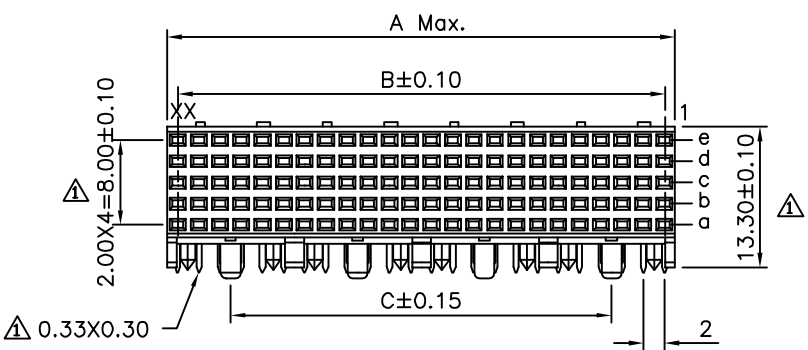
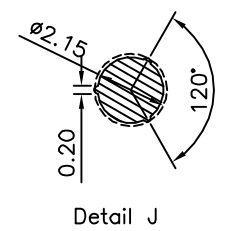
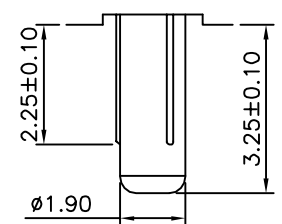
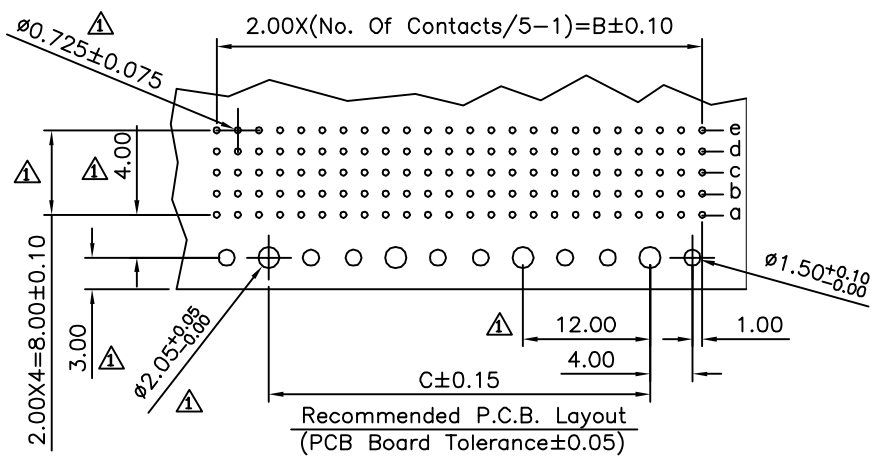

Position	A	B	C
30	11.95	10	0
60	23.95	22	12
90	35.95	34	24
120	47.95	46	36
150	59.95	58	48
180	71.95	70	60
210	83.95	82	72
240	95.95	94	84
270	107.95	106	96
300	119.95	118	108
330	131.95	130	120
360	143.95	142	132
390	155.95	154	144

4UCON 元化興業股份有限公司
 4UCON TECHNOLOGY INC.

DRAWING No.		APPROVED BY		UNLESS OTHERWISE SPECIFIED TOLERANCES ARE X. ±0.5 .X ±0.25 .XX ±0.15
05605		EMILY		
		CHECKED BY HZF		
		DRAWING BY YBL		
SCALE	NONE	REV.	A2	UNIT mm

NO.	REV.	REVISIONS	CHK	DATE
△A2		Modify Data	HZF	10/15/2013
△A1		Modify Data	HZF	09/24/2009
△A0		NEW RELEASE		