

△ SPECIFICATION

Current Rating:10Amps/Way Max.
 Voltage Rating:300V AC
 Contact Resistance:20 Milliohms Max.
 Operation Temperature:-40°C To +105°C
 Soldering Reliability Temperature:250°C±10°C,5Sec. Max.
 Wire Range:14~22AWG
 Torque:4Kgf.cm/M2.6
 Contact(Metal Housing):Copper Alloy,Nickel Plated
 Terminal Screw:Steel,Galvanized With Cr3+ Plated
 Wire Guard:Copper Alloy,Tin Plated
 △ Insulator Body(Housing):Polyamide(UL94V-0),Blue
 RoHS Compliant

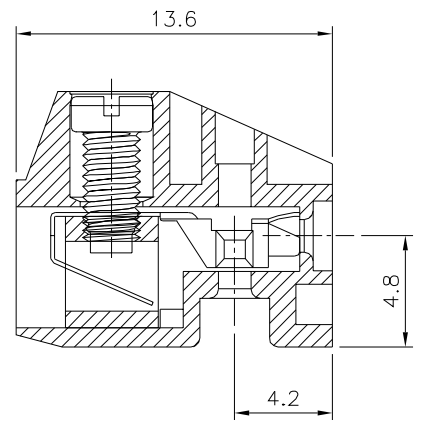
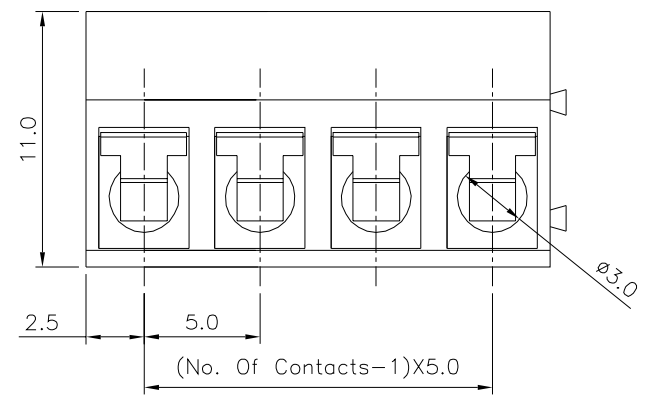
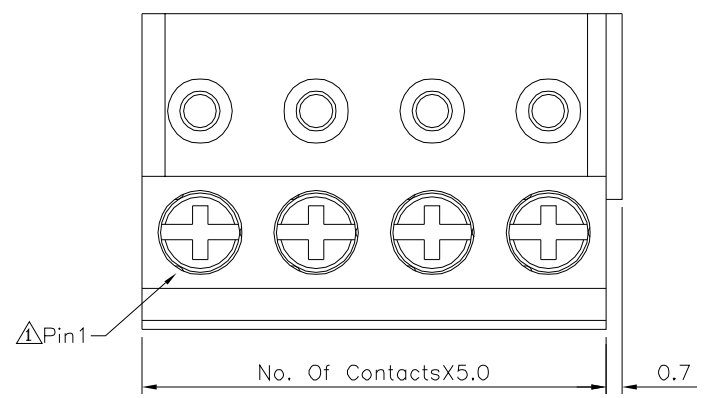

4UCON 元化興業股份有限公司
 4UCON TECHNOLOGY INC.

DRAWING No. △
05341

APPROVED BY MEI
 CHECKED BY HZF
 DRAWING BY SAN

UNLESS OTHERWISE SPECIFIED TOLERANCES ARE
 X. ±0.50
 .X ±0.30
 .XX ±0.20
 ANG. ±1°

SCALE NONE REV. A2 UNIT mm

NO.	REV.	REVISIONS	CHK	DATE
△ A2		Modify Data	HZF	10/16/2021
△ A1		Modify Data	HZF	05/02/2014
△ A0		NEW RELEASE	HZF	04/29/2009