

SPECIFICATION
 Current Rating: 1 Amps
 Voltage Rating: 250V AC
 Withstanding Voltage: 500V(One Minute)
 Contact Resistance: 30 Milliohms Max.
 Insulation Resistance: 1000 Megaohms Min.
 At 500V DC
 Operating Temperature: -55°C~+105°C
 Shell: Steel, Nickel Plated
 Insulator: PBT+30%G.F.(UL94V-0)
 Contact: Brass
 Gold Flash On Contact Area,
 Tin Plated On Solder Tails, Over Nickel
 Boardlock: Steel, Tin Plated
 Rivet: Brass, Nickel Plated
 RoHS Compliant

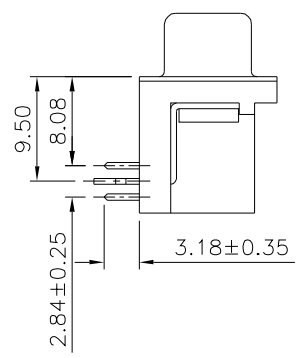
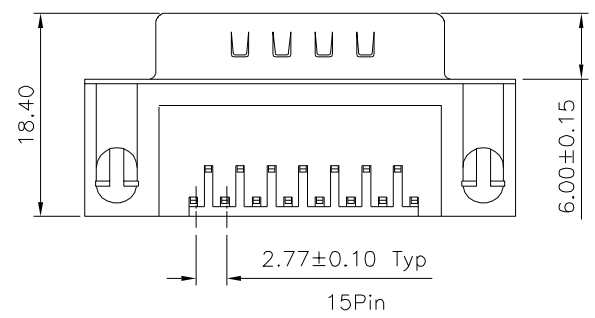
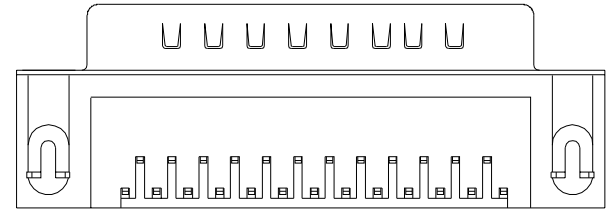
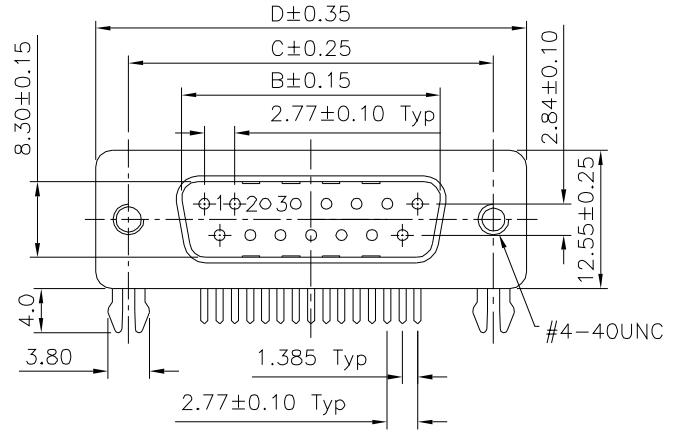
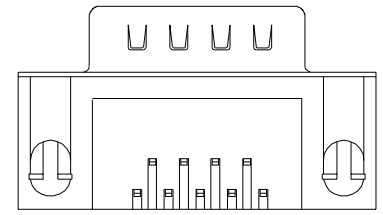
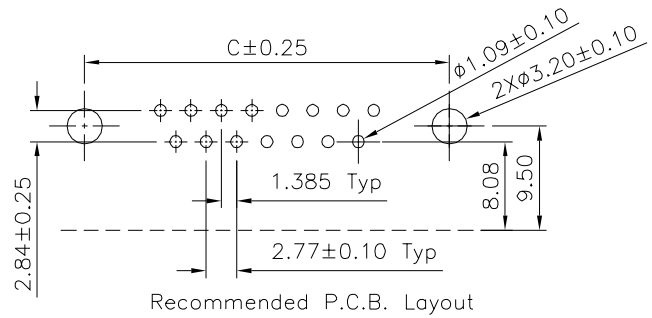

Pin	B	C	D
09	16.92	24.99	30.81
15	25.25	33.32	39.20
25	38.96	47.04	53.04
37	55.42	63.50	69.40

4UCON 元化興業股份有限公司
 4UCON TECHNOLOGY INC.

DRAWING No.		APPROVED BY		UNLESS OTHERWISE SPECIFIED TOLERANCES ARE .X ±0.38 .X* ±3* .XX ±0.25 .XX* ±1* .XXX ±0.05 .XXX* ±0.5*
02845		MEI		
		CHECKED BY	HZF	
		DRAWING BY	CYP	
SCALE	NONE	REV.	BO	UNIT mm

NO.	REV.	BO	NEW RELEASE	HZF	07/19/2021
			REVISIONS	CHK	DATE