

Recommended P.C.B. Layout

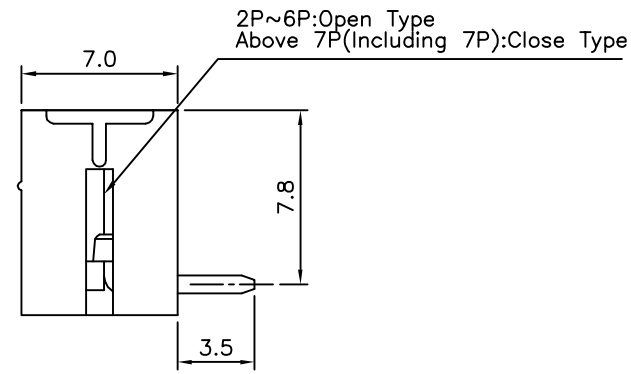
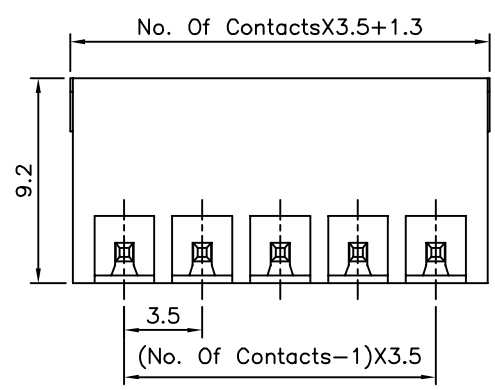
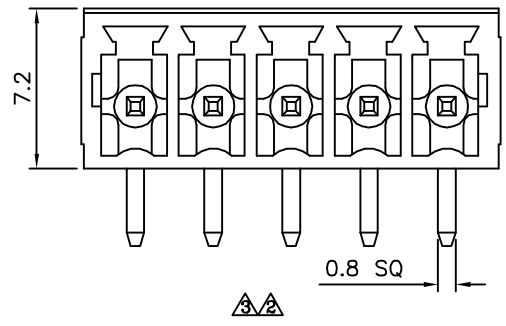

△ SPECIFICATION

Current Rating:12 Amp/Way Max.
 Voltage Rating:300V AC
 Withstanding Voltage:2500V AC For 1 Minute
 Test Time=60 Sec/1 PCS
 Operation Temperature:-40°C~+105°C
 Soldering Reliability:Test Temperature=250°C±10°C
 5 Seconds Max.

**△ Insulator Body(Housing):Polyamide+G.F.(UL94V-0),Green
 Solder Pin:Copper Alloy,Tin Plated
 RoHS Compliant**

4UCON 元化興業股份有限公司
 4UCON TECHNOLOGY INC.

DRAWING No.		APPROVED BY		UNLESS OTHERWISE SPECIFIED TOLERANCES ARE X. ±0.50 .X ±0.30 .XX ±0.20 X* ±1°
19857		EMILY		
		CHECKED BY HZF		
		DRAWING BY HAO		UNIT
SCALE	NONE	REV.	A4	mm

△ A4	Modify Data	HZF	09/04/2015
△ A3	Modify Data	HZF	05/31/2012
△ A2	Modify Data	HZF	11/23/2011
△ A1	Modify Data	HZF	07/30/2010
△ A0	NEW RELEASE	HZF	04/07/2009
NO. REV.	REVISIONS	CHK	DATE