

SPECIFICATION

Voltage Rating:100V AC,DC
 Current Rating:2A AC,DC
 Withstanding Voltage:800V AC/Minute
 Insulation Resistance:1000 Megaohms Min.
 Contact Resistance:Initial Value/10 Milliohms Max.

After Environmental Testing 20 Milliohms Max.

- ⚠ Temperature Range:-40°C~+85°C
- ⚠ Insulator&Cap:PA6T(UL94V-0)
- Contact:High Strength Brass,Tin Plated Over Nickel
- Applicable PC Board Thickness:0.8~1.6mm
- RoHS Compliant

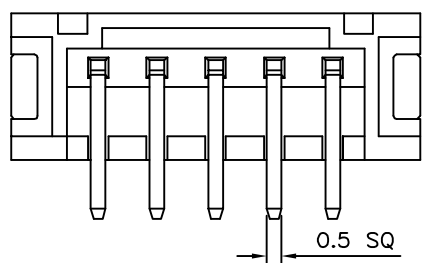
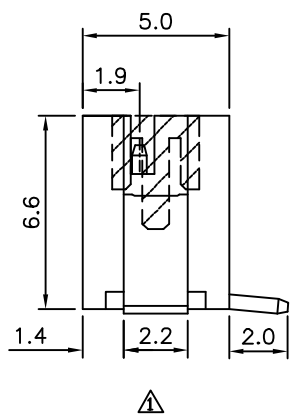
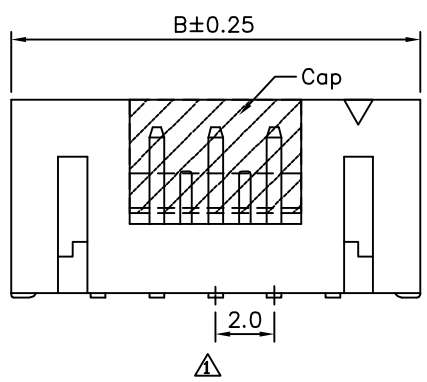
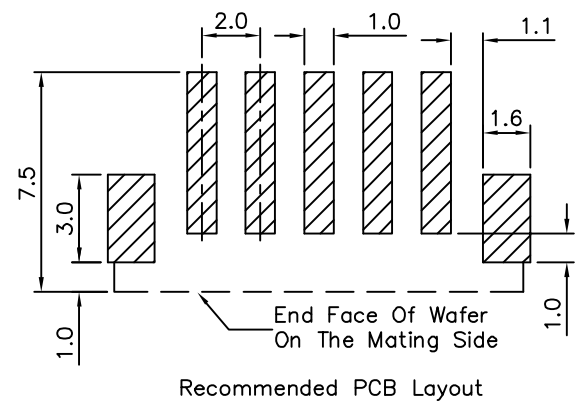
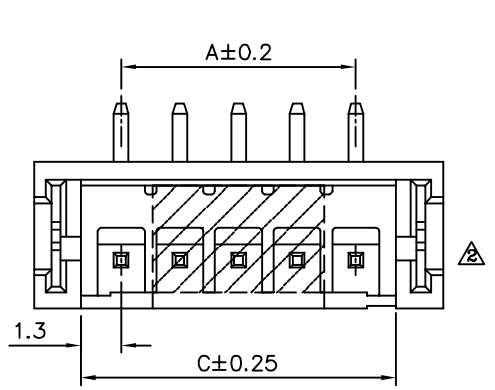

Pin	A	B	C
02	2.00	8.00	4.80
03	4.00	10.00	6.80
04	6.00	12.00	8.80
05	8.00	14.00	10.80
06	10.00	16.00	12.80
07	12.00	18.00	14.80
08	14.00	20.00	16.80
09	16.00	22.00	18.80
10	18.00	24.00	20.80
11	20.00	26.00	22.80
12	22.00	28.00	24.80
13	24.00	30.00	26.80
14	26.00	32.00	28.80
15	28.00	34.00	30.80
16	30.00	36.00	32.80

4UCON 元化興業股份有限公司
 4UCON TECHNOLOGY INC.

DRAWING No.		APPROVED BY		UNLESS OTHERWISE SPECIFIED TOLERANCES ARE .X ±0.35 .XX ±0.25 ANG.
18665		MEI		
		CHECKED BY HZF		
		DRAWING BY SAN		UNIT mm
SCALE	NONE	REV.	A2	

NO.	REV.	REVISIONS	CHK	DATE
⚠	A2	Modify Data	HZF	05/28/2014
⚠	A1	Modify Data	HZF	10/24/2012
⚠	A0	NEW RELEASE	HZF	04/11/2010

SPECIFICATION
 Q'ty:1000 PCS/Reel
 RoHS Compliant

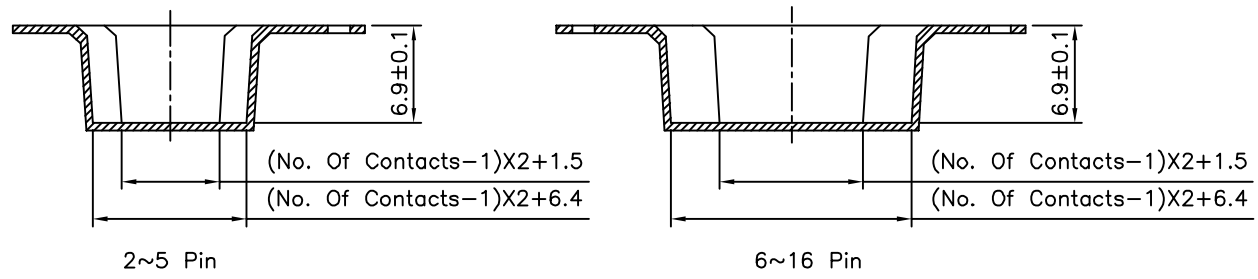
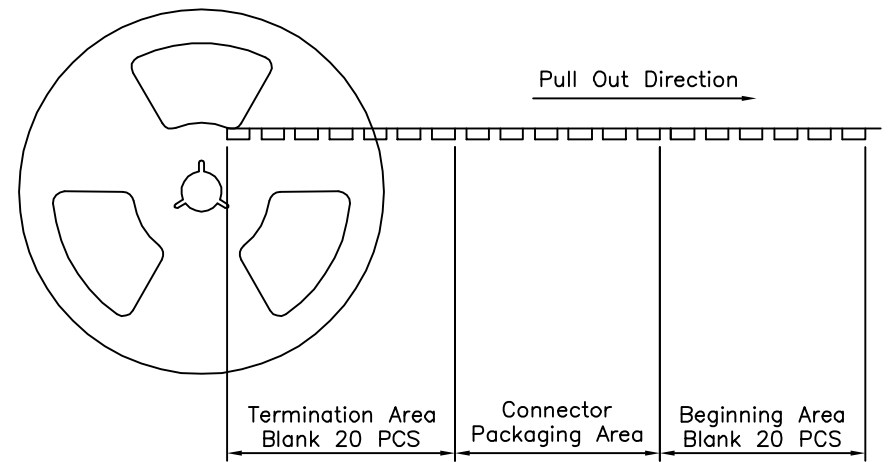
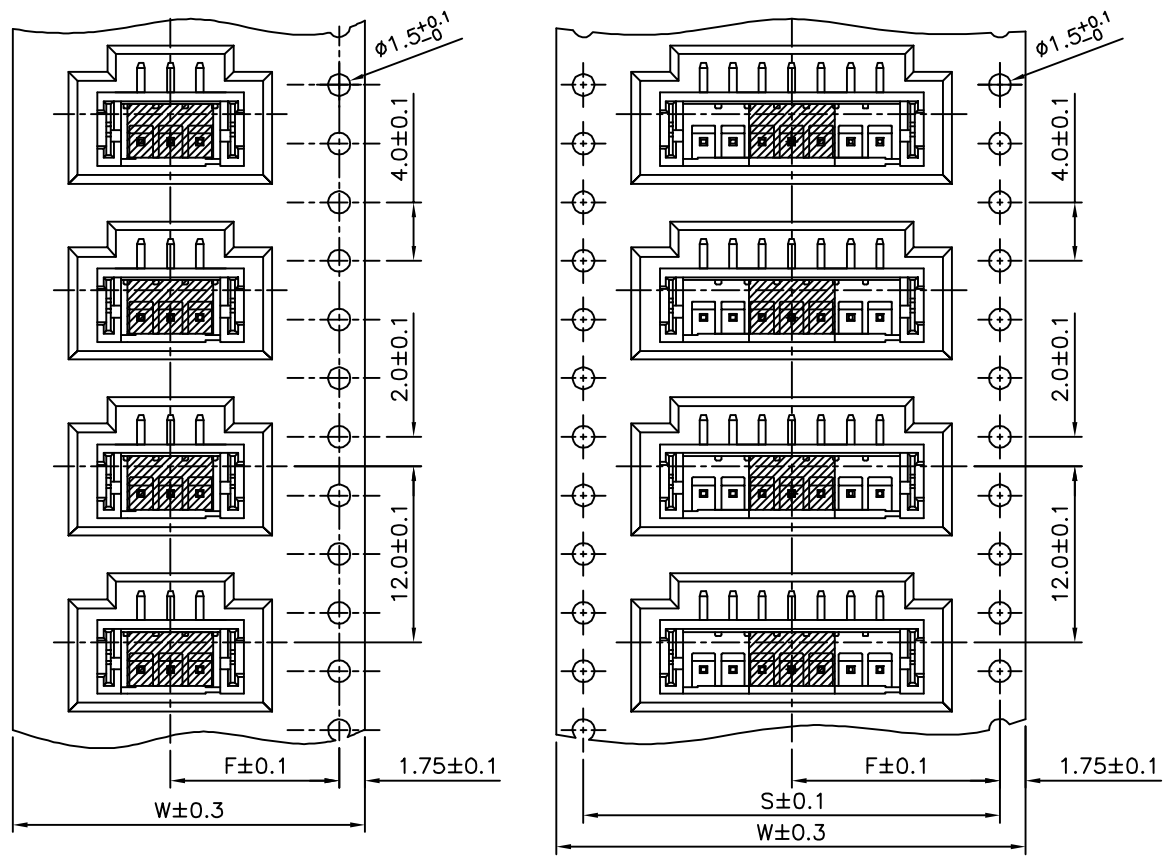

Pin	W	F	S
2~5	24	11.5	-
6~9	32	14.2	28.4
10~14	44	20.2	40.4
15~16	56	26.2	52.4

4UCON 元化興業股份有限公司
 4UCON TECHNOLOGY INC.

DRAWING No.		APPROVED BY		UNLESS OTHERWISE SPECIFIED TOLERANCES ARE .X ±0.25 .XX ±0.15 ANG.
18665		MEI		
		CHECKED BY HZF		
		DRAWING BY SAN		
SCALE	NONE	REV.	A2	UNIT mm

NO.	REV.	REVISIONS	CHK	DATE
△A2		Modify Data	HZF	05/28/2014
△A1		Modify Data	HZF	10/24/2012
△A0		NEW RELEASE	HZF	04/11/2010