

△ SPECIFICATION
 Current Rating:2A
 Voltage Rating:100V AC
 Contact Resistance:20 Milliohms Max.
 Dielectric Withstanding Voltage:800V AC/Minute
 Insulation Resistance:1000 Megaohms Min.
 Temperature Range:-25°C~+85°C
 Insulator:PA66(UL94V-0),White
 Contact:Brass,Tin Plated
 Applicable P.C. Board Thickness:0.8~1.6mm
 RoHS Compliant

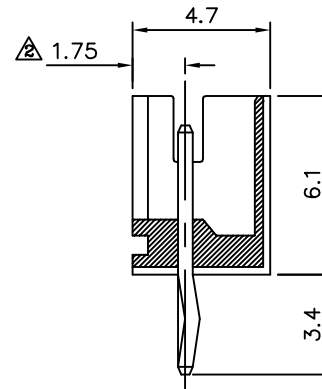
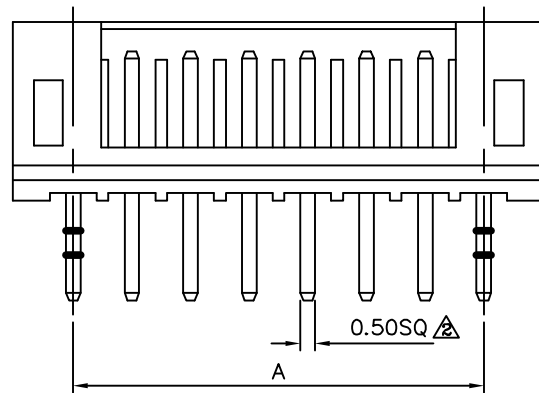
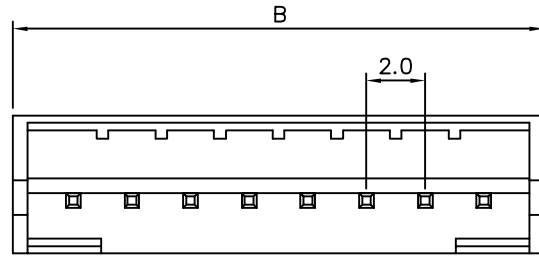

Pin	A	B
2	2.0	6.1
3	4.0	8.1
4	6.0	10.1
5	8.0	12.1
6	10.0	14.1
7	12.0	16.1
8	14.0	18.1
9	16.0	20.1
10	18.0	22.1
11	20.0	24.1
12	22.0	26.1
13	24.0	28.1
14	26.0	30.1
15	28.0	32.1
16	30.0	34.1

4UCON 元化興業股份有限公司
 4UCON TECHNOLOGY INC.

DRAWING No. 01529

APPROVED BY MEI
 CHECKED BY HZF
 DRAWING BY LXX

UNLESS OTHERWISE SPECIFIED
 TOLERANCES ARE
 .X ±0.3
 .XX ±0.2
 ANG.

SCALE NONE

REV. A2

UNIT mm

NO.	REV.	REVISIONS	CHK	DATE
△A2		Modify Data	HZF	03/23/2010
△A1		Modify Data	BECKY	2005/02/17
△A0		NEW RELEASE		