

Recommended P.C.B. Layout

SPECIFICATION

Current Rating: 1.5 Amp/Contact Max.
 Withstand Voltage: 450V AC/Minute
 Contact Resistance: 20 Milliohms Max./Contact
 Insulation Resistance: 1000 Megaohms Min. At 100V
 Operation Temperature: -55°C ~ +105°C
 Contact: Phosphor Bronze, Gold Flash Over Nickel
 Insulator: PA6T+30%G.F.(UL94V-0), Black
 RoHS Compliant

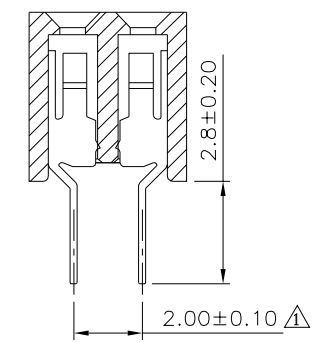
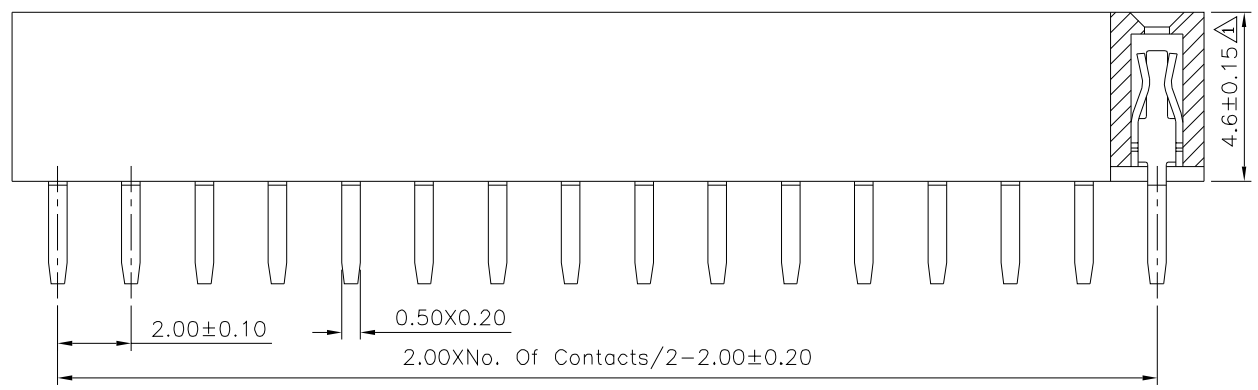
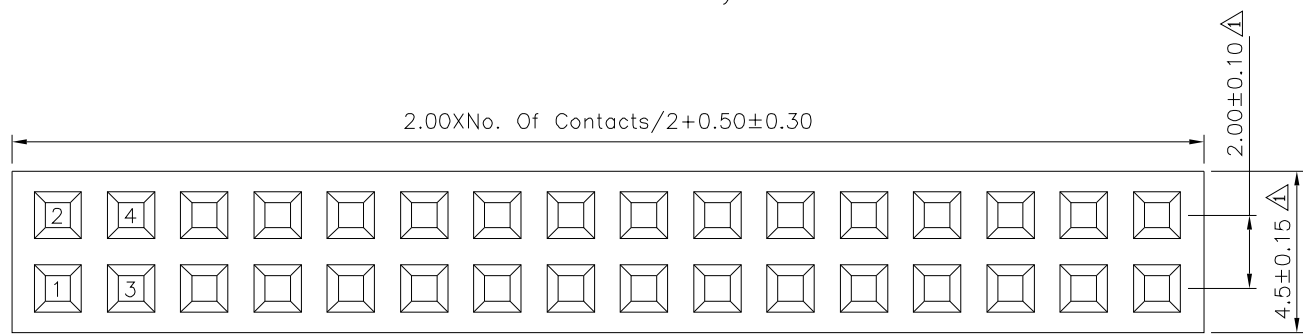

4UCON 元化興業股份有限公司
 4UCON TECHNOLOGY INC.

DRAWING No.		APPROVED BY		UNLESS OTHERWISE SPECIFIED TOLERANCES ARE X. ± 0.50 .X ± 0.30 .XX ± 0.20 .XXX ± 0.10 ANG. $\pm 5^\circ$
00356		MEI		
		CHECKED BY HZF		
		DRAWING BY CYP		
SCALE	NONE	REV.	A1	UNIT mm

NO.	REV.	REVISIONS	CHK	DATE
△A1		Modify Data	HZF	02/24/2017
△A0		NEW RELEASE	HZF	04/14/2013