

**SPECIFICATION**  
 Current Rating:8A  
 Voltage Rating:300V  
 Withstanding Voltage:1600V/Minute  
 Operation Temperature:-40°C~+105°C  
 Wire Range:28-16 AWG  
 Screw/Torque:M2/0.2N.m Max.  
 RoHS Compliant  
 \* 02~24P Available~

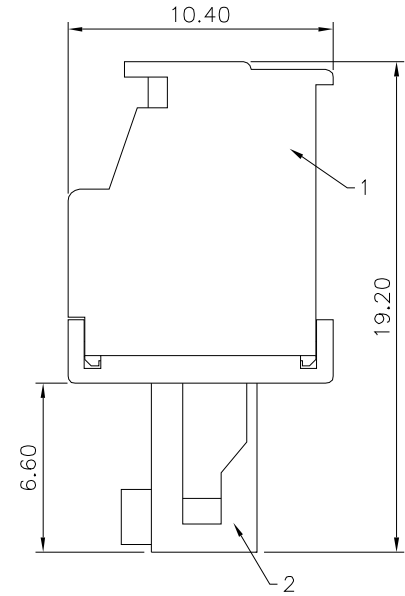
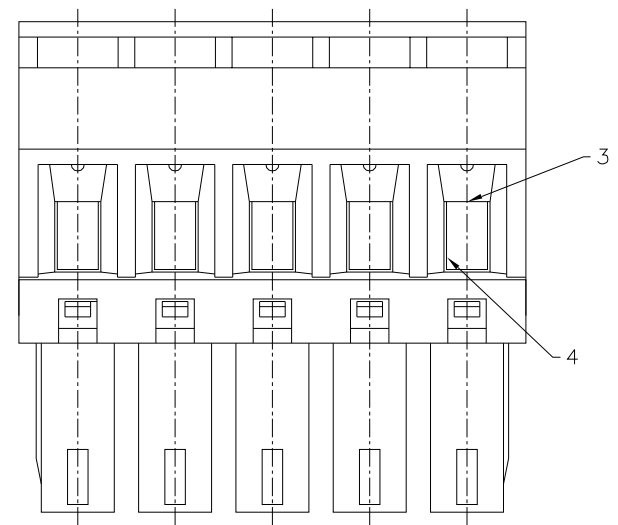
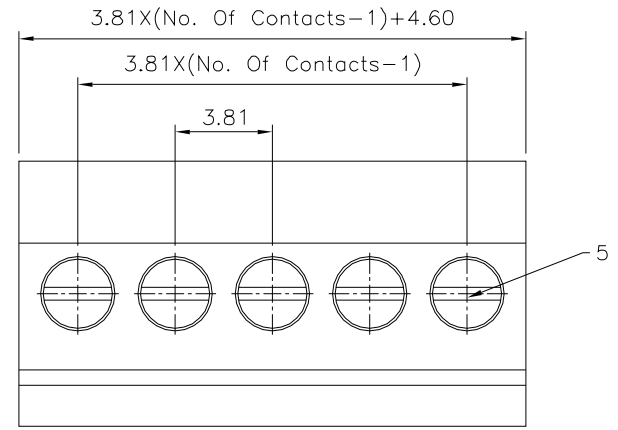

Item	Name	Material	Notes
1	Housing	PA66(UL94V-0)	Green
2	Cover	PA66(UL94V-0)	Green
3	Clamp	Copper Alloy	Tin Plated
4	Cage	Copper Alloy	M2/Nickel Plated
5	Screw	Steel	M2/Zinc Plated

**4UCON** 元化興業股份有限公司  
 4UCON TECHNOLOGY INC.

DRAWING No.		APPROVED BY		UNLESS OTHERWISE SPECIFIED TOLERANCES ARE 0<L≤6 ±0.20 6<L≤10 ±0.30 10<L≤30 ±0.50 30<L≤60 ±0.70 60<L≤100 ±1.00 100<L≤160 ±1.30 160<L ±1.60
22846		MEI		
		CHECKED BY		
		HZF		
		DRAWING BY		
		LSM		
SCALE	NONE	REV.	A0	UNIT
				mm

NO.	REV.	DESCRIPTION	CHK	DATE
△A0		NEW RELEASE	HZF	08/21/2024
		REVISIONS		