

△△△ SPECIFICATION
 Current Rating:1A
 Voltage Rating:100V AC
 Withstand Voltage:500V AC/Minute
 Contact Resistance:20 Milliohms Max.
 Insulation Resistance:1000 Megaohms Min.
 Operation Temperature:-40°C~+105°C
 Insulator:PA6T(UL94V-0),Black
 Contact:Brass,Gold Flash Over Nickel
 No. Of Contacts:06~100 Contacts
 RoHS Compliant

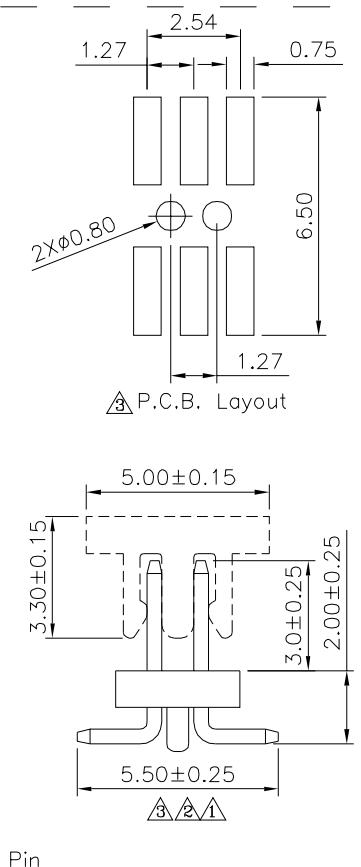
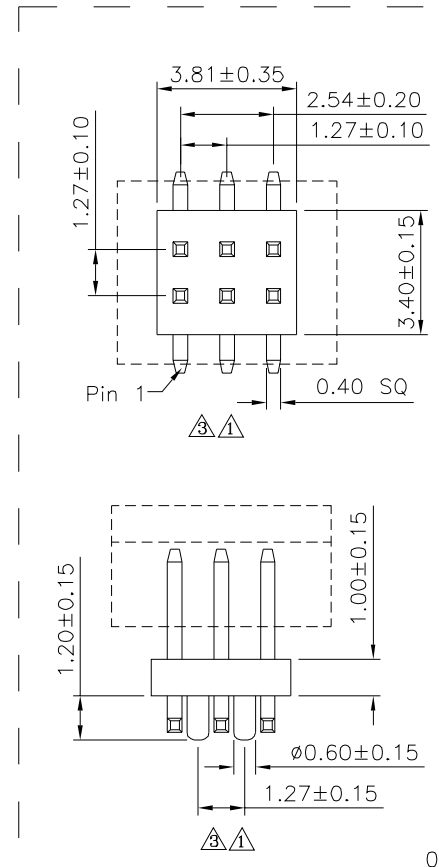
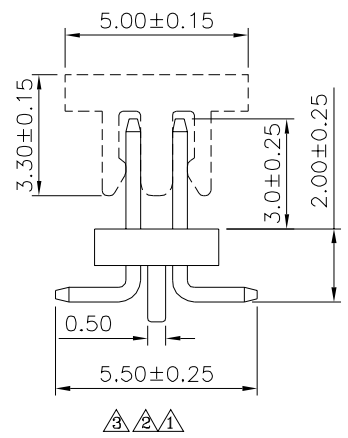
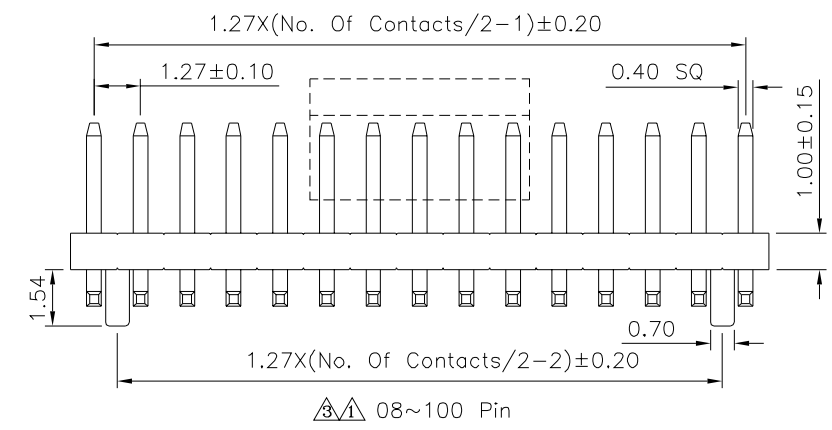
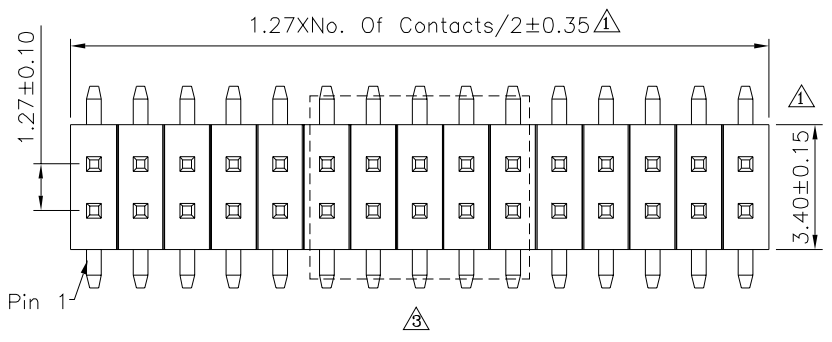
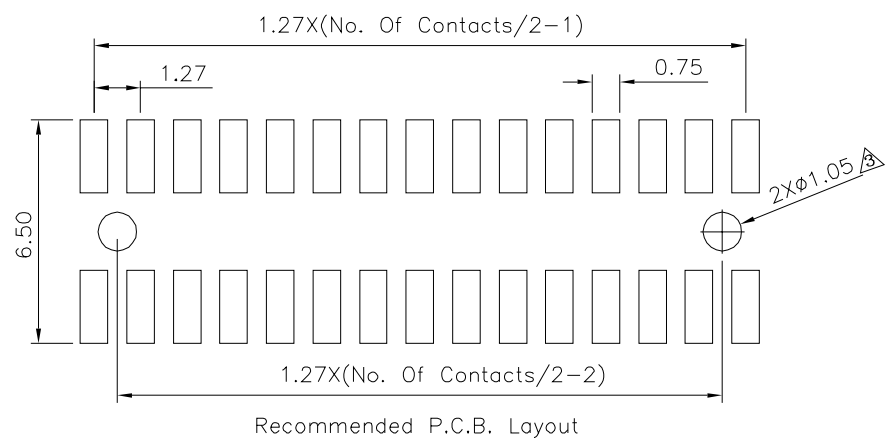

4UCON 元化興業股份有限公司
 4UCON TECHNOLOGY INC.

DRAWING No. △		APPROVED BY	
16902		MEI	
		CHECKED BY	
		HZF	
		DRAWING BY	
		CYP	
SCALE	NONE	REV.	A3

UNLESS OTHERWISE SPECIFIED TOLERANCES ARE △			
.X	±0.38		
.XX	±0.25		
.XXX	±0.05		
UNIT	mm		
NO. REV.	REVISIONS	CHK	DATE
△ A3	Modify Data	HZF	09/06/2024
△ A2	Modify Data	HZF	09/22/2016
△ A1	Modify Data	HZF	07/29/2011
△ A0	NEW RELEASE	HZF	12/02/2008