

△△ SPECIFICATION
 Current:1A
 Contact Resistance:20 Milliohms Max.
 Insulation Resistance:5000 Megaohms Min.
 Dielectric Strength:1000V AC/Minute
 Operating Temperature:-55°C~+105°C
 Housing:PA6T(UL94V-0),Black
 △ Contact:Brass,Gold Flash Over Nickel
 No. Of Contacts:04~100 Contacts
 RoHS Compliant

△ Recommended P.C.B. Layout

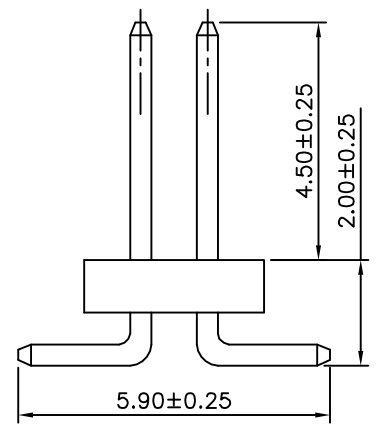
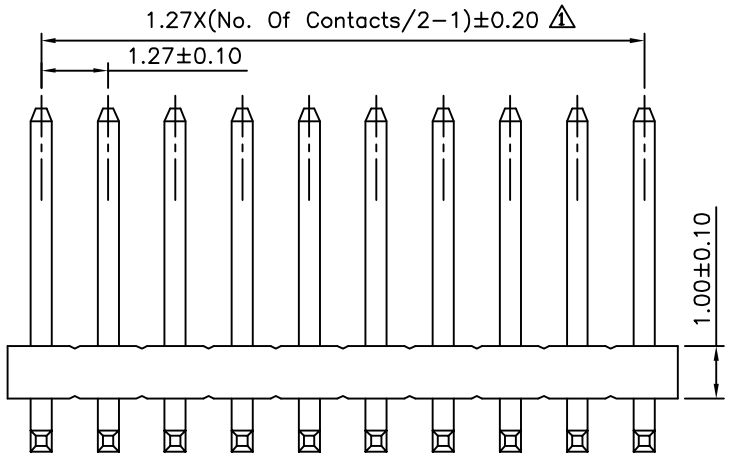

4UCON 元化興業股份有限公司
 4UCON TECHNOLOGY INC.

DRAWING No.		APPROVED BY		UNLESS OTHERWISE SPECIFIED TOLERANCES ARE .X ±0.38 .XX ±0.25 ANG. ±5°
16844		EMILY		
		CHECKED BY HZF		
		DRAWING BY YBL		UNIT mm
SCALE	NONE	REV.	A3	

NO.	REV.	REVISIONS	CHK	DATE
△	A3	Modify Data	HZF	11/26/2013
△	A2	Modify Data	HZF	05/17/2011
△	A1	Modify Data	HZF	11/13/2009
△	A0	NEW RELEASE	BECKY	02/04/2005