

△△ SPECIFICATION

Voltage Rating:300V AC
 Current Rating:16 Amps/Way Max.
 Contact Resistance:20 Milliohms Max.
 Withstanding Voltage:2500V AC(1 Minute)
 Test Time=60s/PCS
 Wire Range:12~30 AWG
 △ Torque:4.5 Kgf.cm/M3.0
 Operation Temperature:-40°C~+105°C
 Soldering Reliability:250°C±10°C/5s Max.
 Contact(Metal Housing):Copper Alloy,Nickel Plated
 Terminal Screw:Steel,Galvanized With Cr3+ Plated
 Solder Pin:Copper Alloy,Tin Plated
 Insulator Body(Housing):Polyamide(UL94V-0),Green
 RoHS Compliant

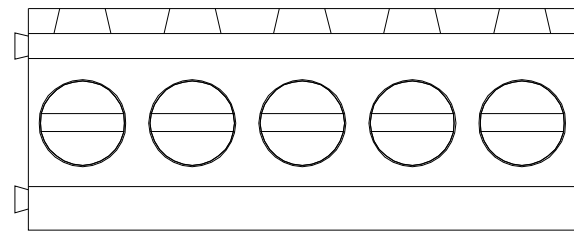

△

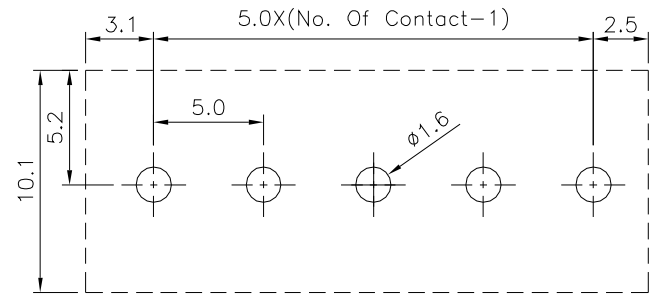

Recommended P.C.B. Layout

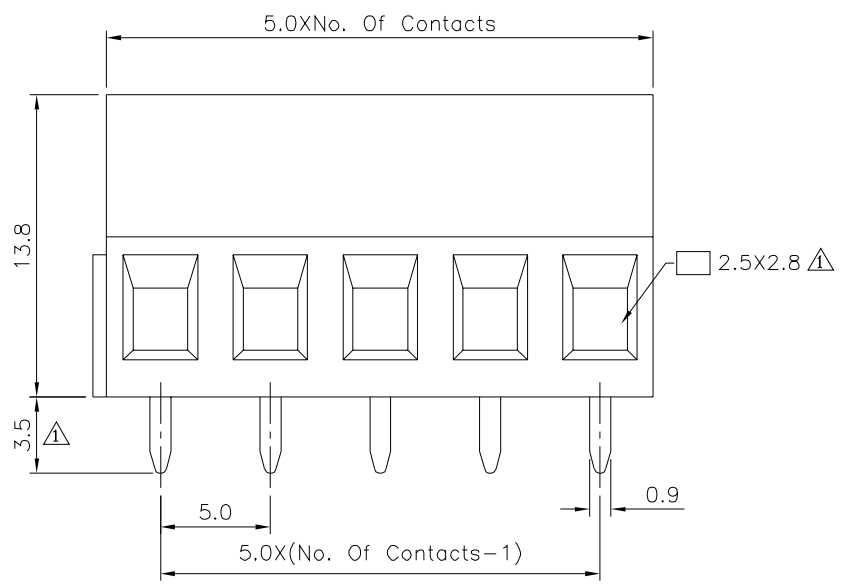

△△

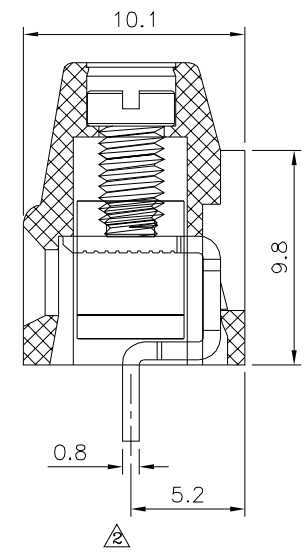

4UCON 元化興業股份有限公司
 4UCON TECHNOLOGY INC.

| | | | | |
|-------------|------|-------------|----|---|
| DRAWING No. | | APPROVED BY | | UNLESS OTHERWISE SPECIFIED TOLERANCES ARE X. ±0.50 .X ±0.30 .XX ±0.20 X.° ±1° |
| 14329 | | MEI | | |
| | | CHECKED BY | | |
| | | HZF | | |
| DRAWING BY | | CYP | | |
| SCALE | NONE | REV. | A3 | UNIT mm |

| | | | | |
|-----|------|-------------|-----|------------|
| NO. | REV. | REVISIONS | CHK | DATE |
| △ | A3 | Modify Data | HZF | 11/04/2017 |
| △ | A2 | Modify Data | HZF | 08/15/2013 |
| △ | A1 | Modify Data | HZF | 11/27/2010 |
| △ | A0 | NEW RELEASE | HZF | 11/19/2009 |