

SPECIFICATION

Rating:100V AC 4A Max.
 Contact Resistance:Pins:30 Milliohms Max.
 Shell:50 Milliohms Max.
 Insulation Resistance:100 Megaohms Min.
 @ 500V DC
 Withstanding Voltage:250V AC RMS For 1 Minute
 RoHS Compliant

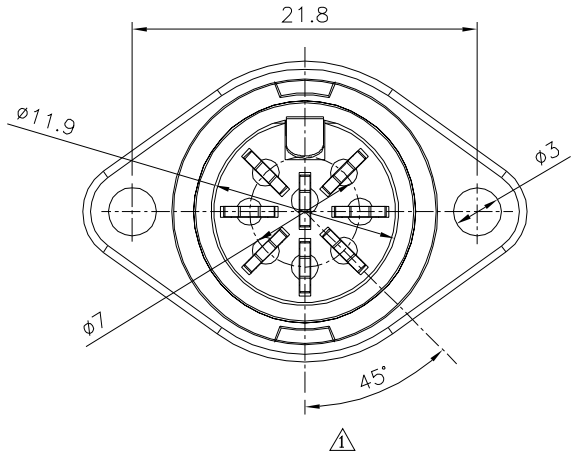

④	Negative Contactor	Copper	Nickel Plated	1
③	Terminals	Brass	Silver Plated	XX
②	Housing	ABS	_____	1
①	Shield Cover	Zn Alloy	Nickel Plated	1
No.	Description	Material	Finish	Q'ty

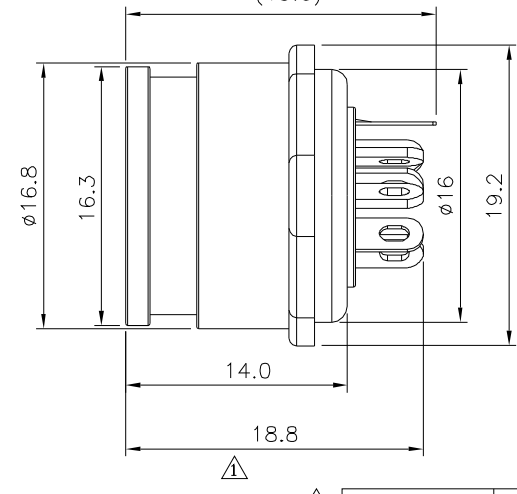
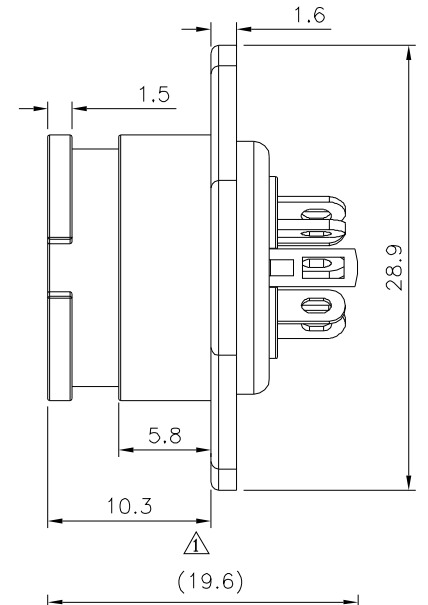
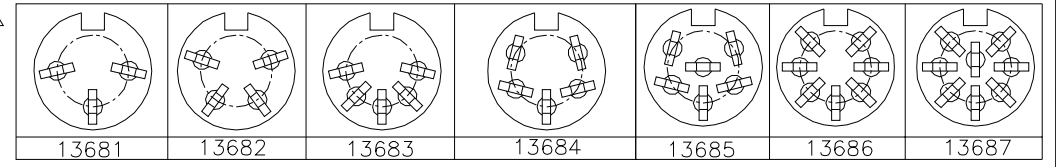

4UCON 元化興業股份有限公司
 4UCON TECHNOLOGY INC.

DRAWING No. 13685

APPROVED BY Jason Wu
 CHECKED BY Leo Han
 DRAWING BY Michelle Lee

UNLESS OTHERWISE SPECIFIED TOLERANCES ARE
 .X ±0.3
 .XX ±0.20

SCALE NONE REV. A1

UNIT mm

NO.	REV.	REVISIONS	CHK	DATE
①	A1	Modify Data	HZF	10/27/2025
②	A0	NEW RELEASE	HZF	02/14/2014