

△ SPECIFICATION

Current Rating:1.0A AC/DC
 Voltage Rating:125V AC/DC
 Contact Resistance:20 Milliohms Max.
 Withstanding Voltage:250V AC/Minute
 Insulation Resistance:100 Megaohms Min.
 △ Temperature Range:-25°C~+85°C
 Insulator:PA46(UL94V-0),Nature
 Pin:Phosphor Bronze,Tin Plated Over Nickel
 Solder Tab:Brass,Tin Plated Over Nickel
 RoHS Compliant

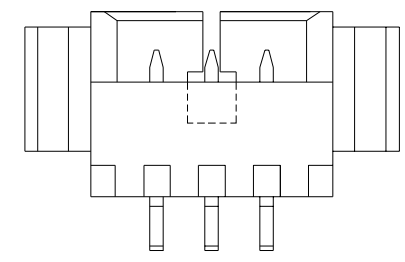

2P,3P

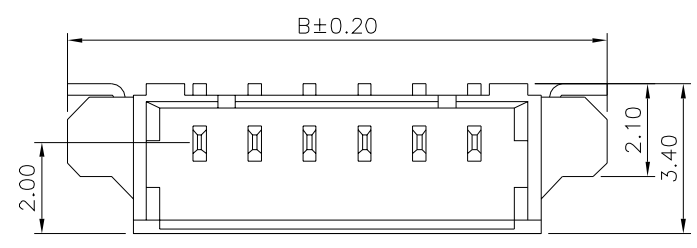
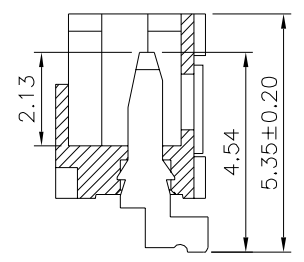

△ Section:A-A

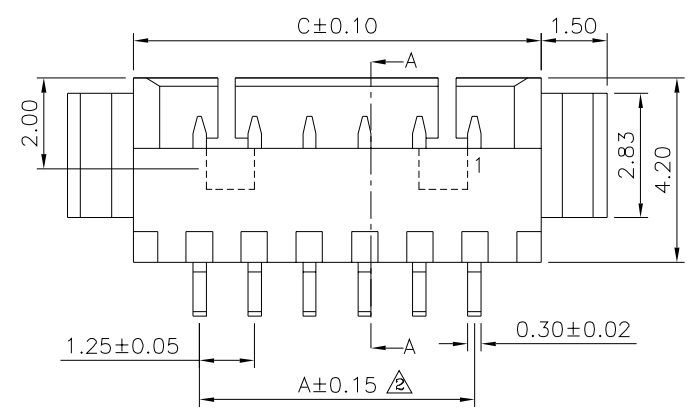

△ 4~15P

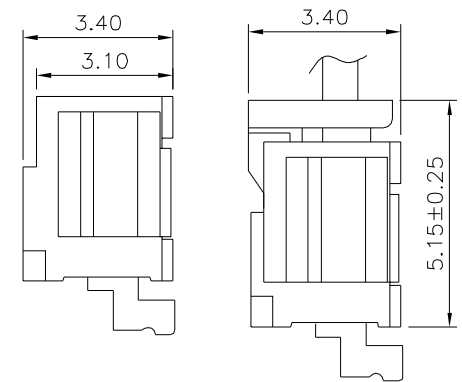

Mating Height Drawing

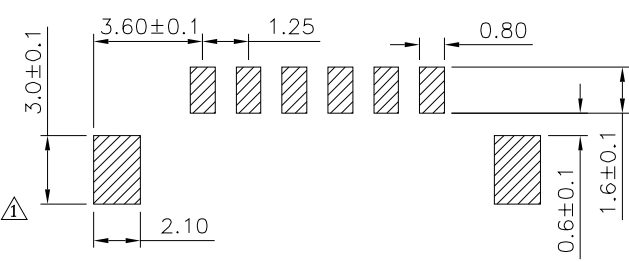
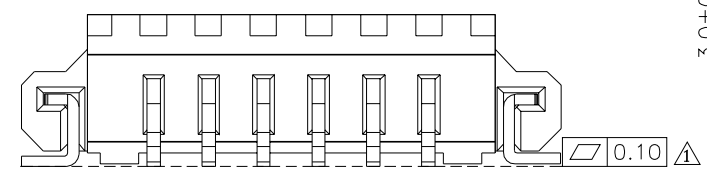

△ Recommended P.C.B. Layout(Top View)
 (PCB Board Tolerance±0.05)

Pin	A	B	C
02	1.25	7.25	4.25
03	2.50	8.50	5.50
04	3.75	9.75	6.75
05	5.00	11.00	8.00
06	6.25	12.25	9.25
07	7.50	13.50	10.50
08	8.75	14.75	11.75
09	10.00	16.00	13.00
10	11.25	17.25	14.25
11	12.50	18.50	15.50
12	13.75	19.75	16.75
13	15.00	21.00	18.00
14	16.25	22.25	19.25
15	17.50	23.50	20.50

4UCON 元化興業股份有限公司
 4UCON TECHNOLOGY INC.

DRAWING No. **12339**

APPROVED BY MEI
 CHECKED BY HZF
 DRAWING BY CYP

UNLESS OTHERWISE SPECIFIED TOLERANCES ARE
 X. ±0.30
 XX ±0.25
 XXX ±0.20
 ANG. ±1°

NO.	REV.	REVISIONS	CHK	DATE
△4	A4	Modify Data	HZF	08/20/2024
△3	A3	Modify Data	HZF	07/17/2023
△2	A2	Modify Data	HZF	12/04/2019
△1	A1	Modify Data	HZF	04/17/2019
△0	A0	NEW RELEASE	HZF	12/30/2015

SCALE NONE REV. A4

