

SPECIFICATION
 Current Rating: 1.5A
 Withstand Voltage: 500V AC
 Contact Resistance: 20 Milliohms Max.
 Insulation Resistance: 1000 Megaohms Min.
 Operation Temperature: -40°C ~ +105°C
 ⚠ Insulator: PA9T (UL94V-0), Black
 Contact: Brass, Gold Flash Over Nickel
 RoHS Compliant

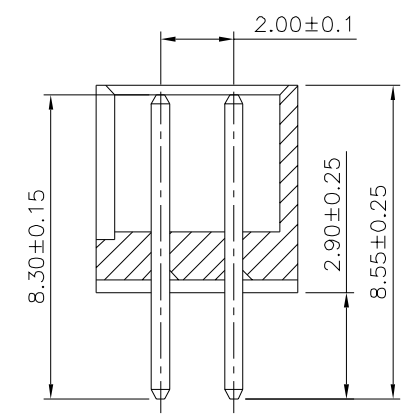
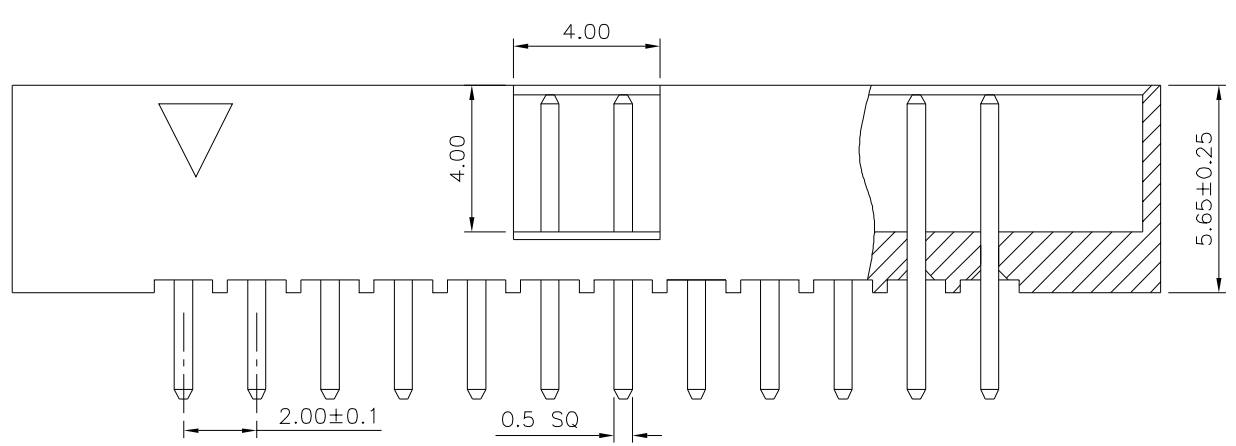
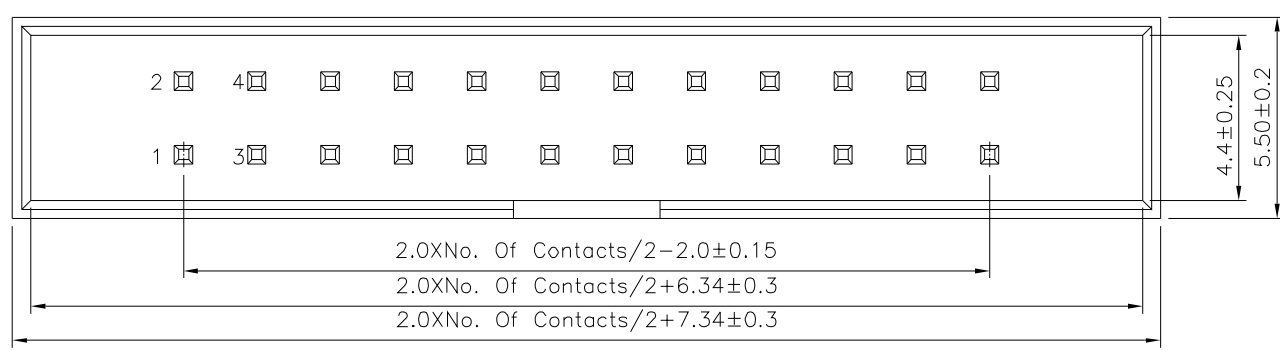

4UCON 元化興業股份有限公司
 4UCON TECHNOLOGY INC.

DRAWING No.		APPROVED BY		UNLESS OTHERWISE SPECIFIED TOLERANCES ARE	
12103		Jason Wu		X. ±0.25 X.* ±2*	
		CHECKED BY		.X ±0.20 .X* ±1.5*	
		Leo Han		.XX ±0.15 .XX* ±1*	
DRAWING BY		Michelle Lee		.XXX ±0.10 .XXX* ±0.5*	
SCALE	NONE	REV.	B1	UNIT	mm

NO.	REV.	REVISIONS	CHK	DATE
⚠	B1	Modify Data	HZF	12/12/2023
⚠	B0	NEW RELEASE	HZF	05/09/2018