

**SPECIFICATION**  
 Current Rating:3A  
 Dielectric Withstanding Volatge:1000V AC/1 Minute  
 Contact Resistance:20 Milliohms Max.  
 Insulation Resistance:5000 Megaohms Min. At 500V DC  
 Operation Temperature:-55°C~+85°C  
 Insertion Force:340g Max. Per Pair  
 Withdrawal Force:28g Min. Per Pair  
 Insulator:PBT+G.F.(UL94V-0)  
 Contact:Brass  
 Gold Flash On Contact Area  
 Tin Plated On Solder Tails,Over Nickel  
 RoHS Compliant

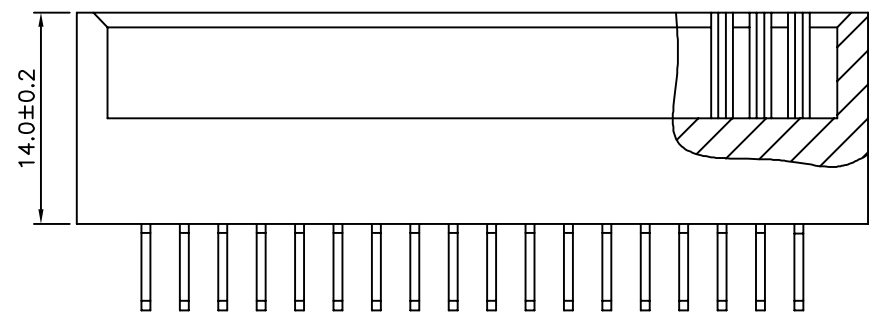
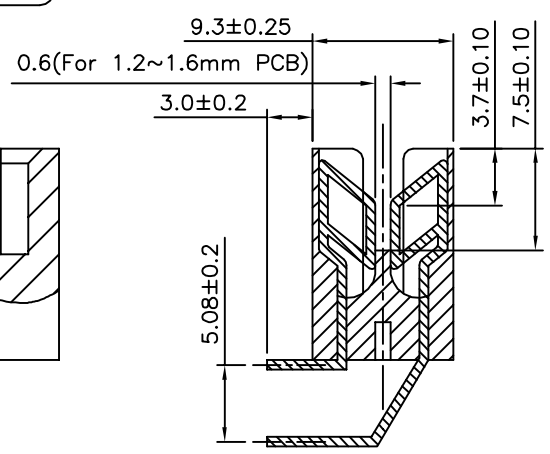
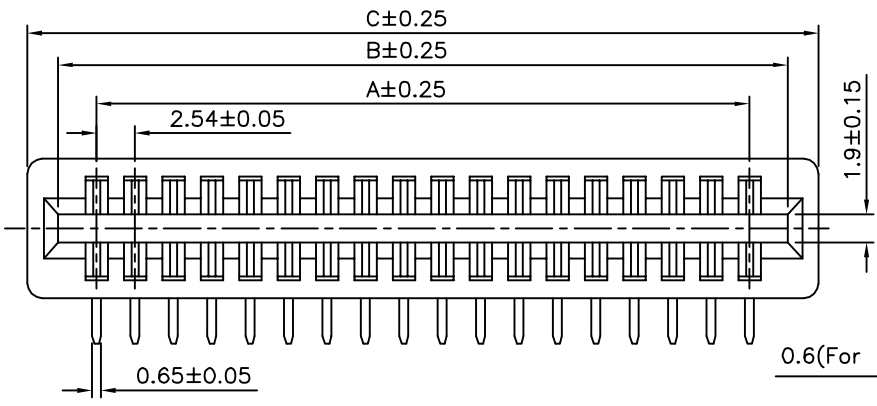
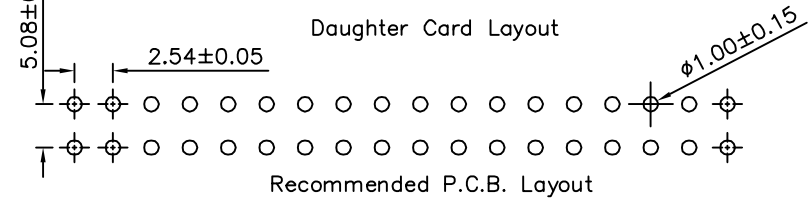
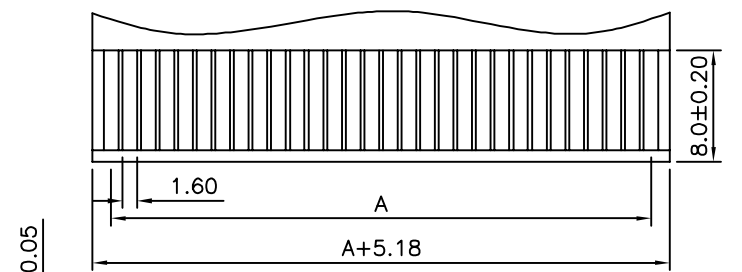
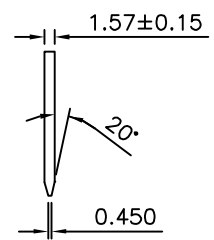

Pin	A	B	C	Pin	A	B	C
6	5.08	10.66	14.22	40	48.26	53.84	57.40
8	7.62	13.20	16.76	42	50.80	56.38	59.94
10	10.16	15.74	19.30	44	53.34	58.92	62.48
12	12.70	18.28	21.84	46	55.88	61.46	65.02
14	15.24	20.82	24.38	48	58.42	64.00	67.56
16	17.78	23.36	26.92	50	60.96	66.54	70.10
18	20.32	25.90	29.46	52	63.50	69.08	72.64
20	22.86	28.44	32.00	54	66.04	71.62	75.18
22	25.40	30.98	34.54	56	68.58	74.16	77.72
24	27.94	33.52	37.08	58	71.12	76.70	80.26
26	30.48	36.06	39.62	60	73.66	79.24	82.80
28	33.02	38.60	42.16	62	76.20	81.78	85.34
30	35.56	41.14	44.70	64	78.74	84.32	87.88
32	38.10	43.68	47.24	66	81.28	86.86	90.42
34	40.64	46.22	49.78	68	83.82	89.40	92.96
36	43.18	48.76	52.32	70	86.36	91.94	95.50
38	45.72	51.30	54.86	72	88.90	94.48	98.04

**4UCON** 元化興業股份有限公司  
 4UCON TECHNOLOGY INC.

DRAWING No. 02906  
 APPROVED BY EMILY  
 CHECKED BY HZF  
 DRAWING BY SONG  
 SCALE NONE REV. CO

UNLESS OTHERWISE SPECIFIED TOLERANCES ARE  
 .X ±0.38  
 .XX ±0.25  
 ANG.  
 UNIT mm

CO	NEW RELEASE	HZF	01/21/2012
NO. REV.	REVISIONS	CHK	DATE