

Recommended P.C.B. Layout

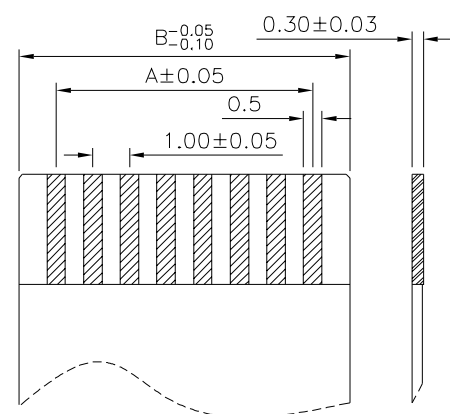

Accommodated FFC/FPC

- △ SPECIFICATION**
- 1. Material & Finish**
- ① Insulator: LCP(UL94V-0), Nature
 - ② Terminal: Phosphor Bronze, Tin Plated
 - ③ Slider: LCP(UL94V-0), Black
 - ④ Latch: Brass, Tin Plated
- △ 2. Electrical Characteristics**
- Voltage Rating: 50V AC/DC
 - Contact Resistance: 40 Milliohms Max.
 - Insulation Resistance: 50 Megaohms Min.
- 3. Environmental Characteristics**
- Temperature Range: -25°C ~ +85°C
- 4. RoHS Compliant**

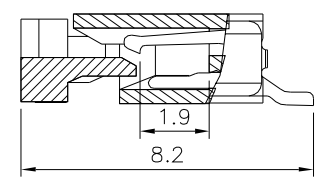
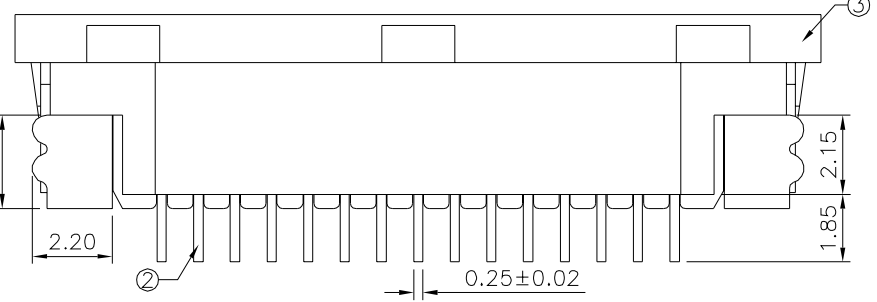
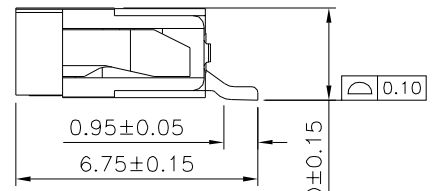
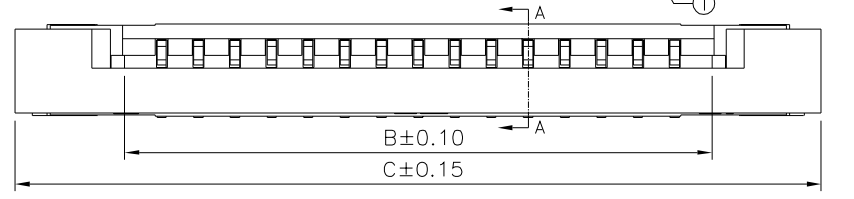
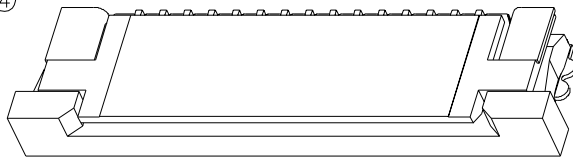
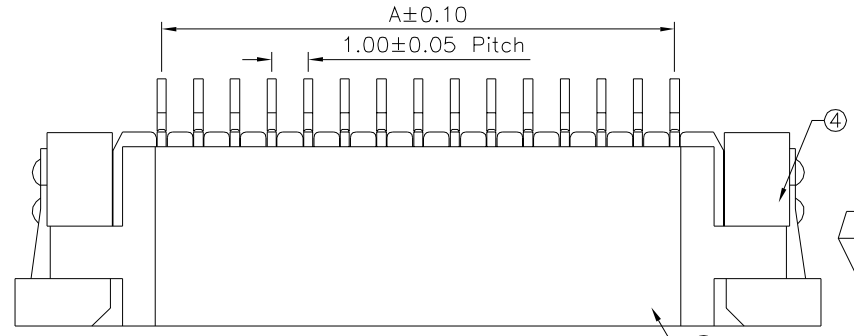

Section A-A

Pin	A	B	C	Pin	A	B	C
*4	3.00	5.03	11.00	23	22.00	24.03	30.00
*5	4.00	6.03	12.00	*24	23.00	25.03	31.00
*6	5.00	7.03	13.00	*25	24.00	26.03	32.00
*7	6.00	8.03	14.00	*26	25.00	27.03	33.00
*8	7.00	9.03	15.00	27	26.00	28.03	34.00
*9	8.00	10.03	16.00	*28	27.00	29.03	35.00
*10	9.00	11.03	17.00	29	28.00	30.03	36.00
*11	10.00	12.03	18.00	*30	29.00	31.03	37.00
*12	11.00	13.03	19.00	31	30.00	32.03	38.00
*13	12.00	14.03	20.00	*32	31.00	33.03	39.00
*14	13.00	15.03	21.00	33	32.00	34.03	40.00
*15	14.00	16.03	22.00	*34	33.00	35.03	41.00
*16	15.00	17.03	23.00	35	34.00	36.03	42.00
*17	16.00	18.03	24.00	*36	35.00	37.03	43.00
*18	17.00	19.03	25.00	37	36.00	38.03	44.00
19	18.00	20.03	26.00	38	37.00	39.03	45.00
*20	19.00	21.03	27.00	39	38.00	40.03	46.00
*21	20.00	22.03	28.00	40	39.00	41.03	47.00
*22	21.00	23.03	29.00				

△△ Note: The Mark Of "*" Are Tooled

4UCON 元化興業股份有限公司
4UCON TECHNOLOGY INC.

DRAWING No. 21789

APPROVED BY Jason Wu
CHECKED BY Leo Han
DRAWING BY Michelle Lee

UNLESS OTHERWISE SPECIFIED TOLERANCES ARE
X. ±0.50
XX ±0.20
XXX ±0.10
XXX ±0.05
ANG. ±1°
UNIT mm

NO.	REV.	REVISIONS	CHK	DATE
△A3		Modify Data	HZF	08/23/2024
△A2		Modify Data	HZF	07/23/2021
△A1		Modify Data	HZF	02/22/2017
△A0		NEW RELEASE	HZF	10/11/2015

SCALE NONE REV. A3